



 Made in Finland

Utu sauna cabin (SHU1212) - Installation instructions



Table of contents SOP1212PF-sauna cabin			
Description	w*d*h / INFO	Quantity	Check
Wall-elements	(w*d*h)		
A	1200*72*2034	1 pc	
B	1170*72*2034	1 pc	
C	1200*72*2034	1 pc	
D	421*72*2034	1 pc	
Roof element	(w*d*h)		
R	1120*1160*64	1 pc	
Mouldings	(w*d*h)		
(outside) back corners, L-shape	21*42*2034 HT aspen	2 pcs	
door/wall joint (inside and outside)	45*15*1953 HT aspen	2 pcs	
(outside) front corners	88*28*2034 HT aspen	2 pcs	
Interior	(w*d*h)		
Bench support(s)	485*28*90 HT aspen	2 pcs	
Upper bench	1046*500*90 HT aspen	1 pc	
Bench skirt	1046*30*325 HT aspen	1 pc	
Lower bench (stool)	600*450*450 HT aspen	1 pc	
Back rest	1046*36*265 HT aspen	1 pc	
Heater guard	523*347*705 HT aspen	1 pc	
Lighting			
RGBW-LED tubes	width 1000	2 pcs	
Mounting clamps	metal clips	4 pcs	
Luci Orilega Power Supply 75W (24V)	LPSOL-075-24-ND-I	1 pc	
All in one controller WTJ5	WTJ5	1 pc	
Remote controller	RTJ4	1 pc	
Heater (not included)			
Recommended heater Delta 3,6 kW	D36	not included	
Stones AC3000	5 - 10 cm	not included	
Glass door with wooden frames			
Door with alder frames and bronze glass	690*1953*72 (glass 620*1913)	1 pc	
Door handle	SAZ110	1 pc	
Counter part for magnet	ZVEL-259C	1 pc	
Front wall support 1212/1616	ZVEL-851	1 pc	
Ventilation			
AIR Vent, alder	SZ093LE	1 pc	
Air duct, chromium	ZVEL-10	1 pc	
Accessories			
Installation instructions	Y05-1274	1 pc	
Screws, nails and tools			
5*80 mm	(SS) Stainless steel	5 pcs	
5*80 mm	Zn	28 pcs	
4,5*45 mm	(SS) Stainless steel	25 pcs	
3*25 mm	(SS) Stainless steel	7 pcs	
1,7*45 mm	dyckert-nail, Zn	20 pcs	
17*10 mm	Frame plug, rubber, beige	8 pcs	





Tools required



Screws

SS = Stainless steel

SS x * x mm

Zn = Zink

Zn x * x mm



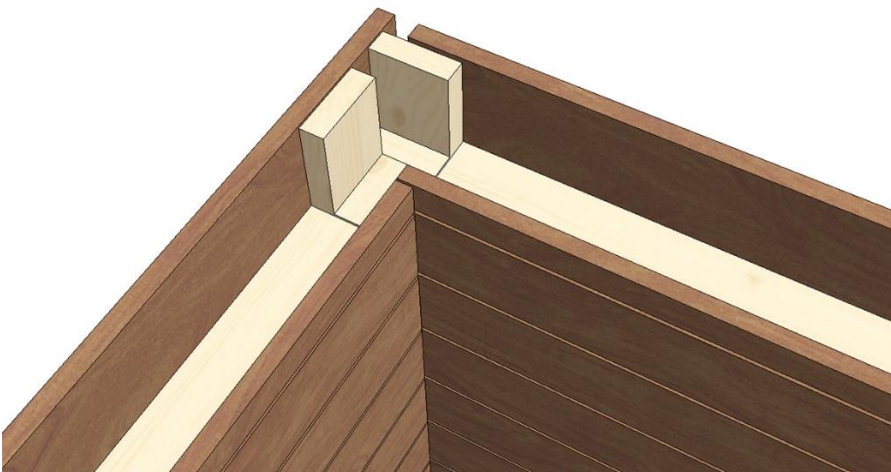
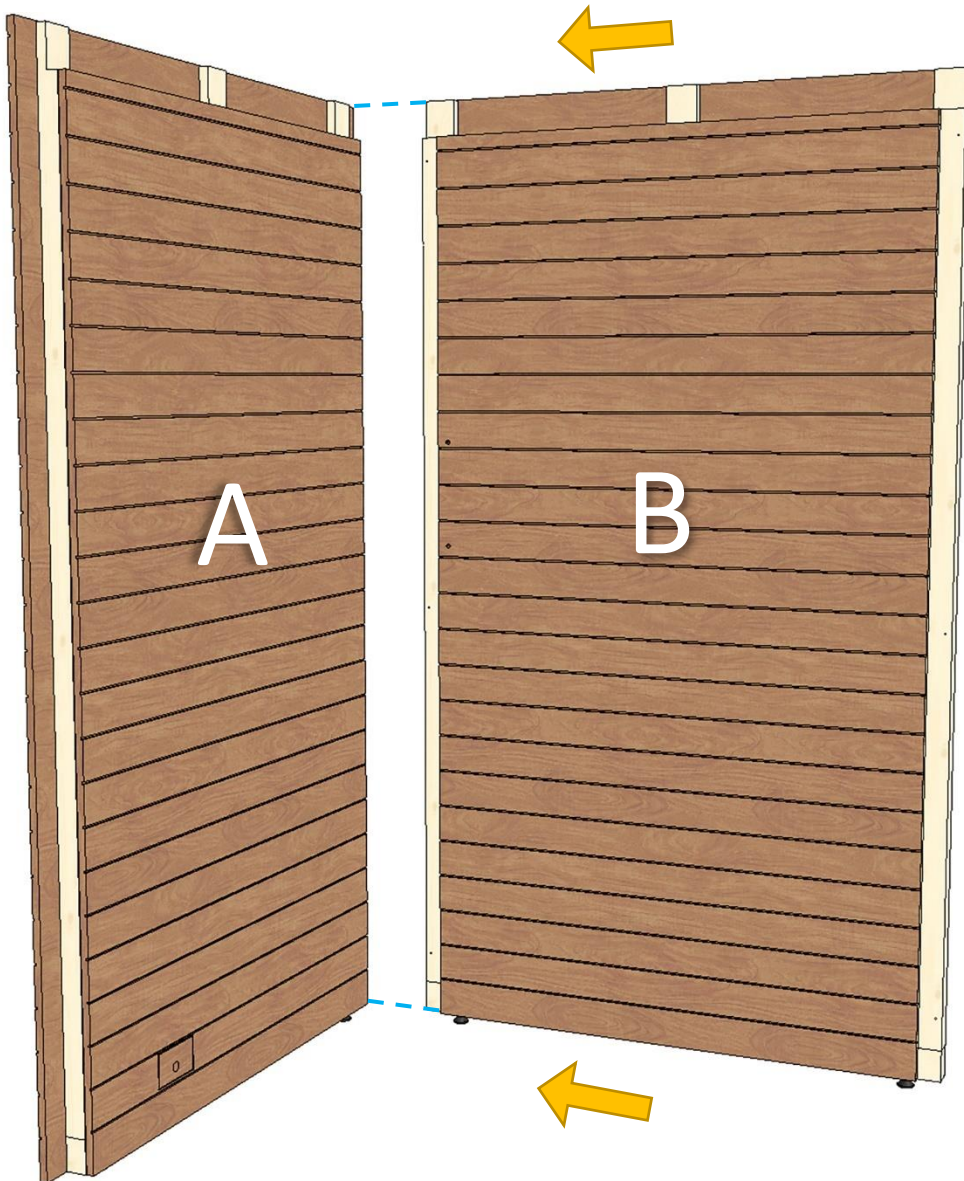

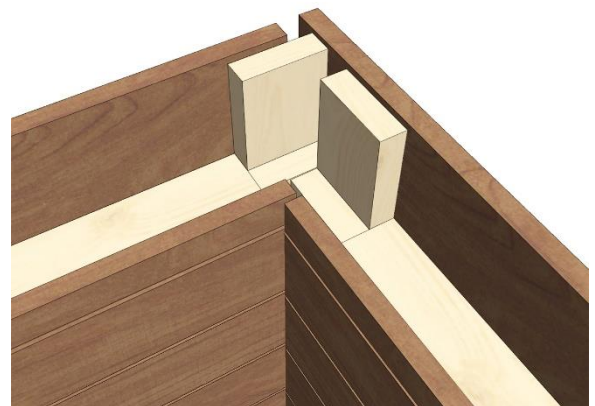
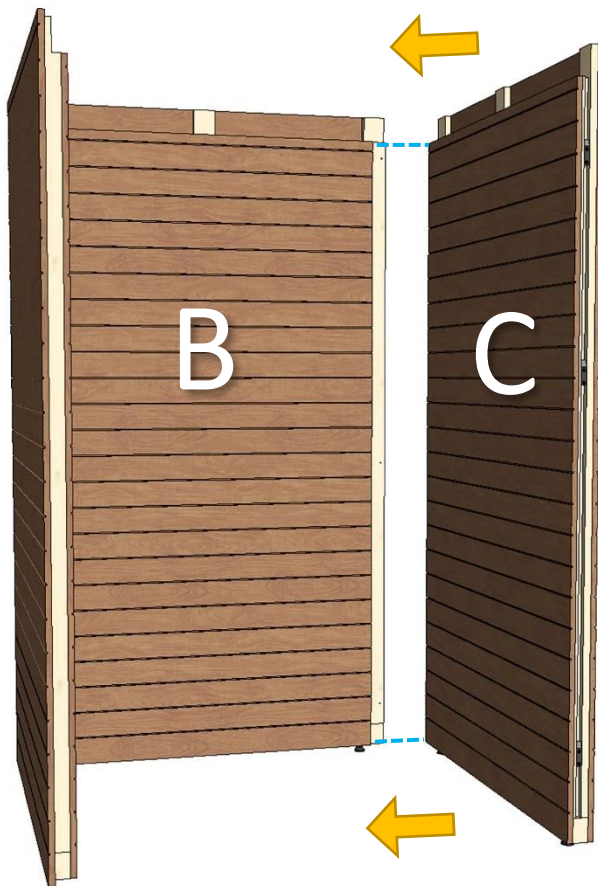
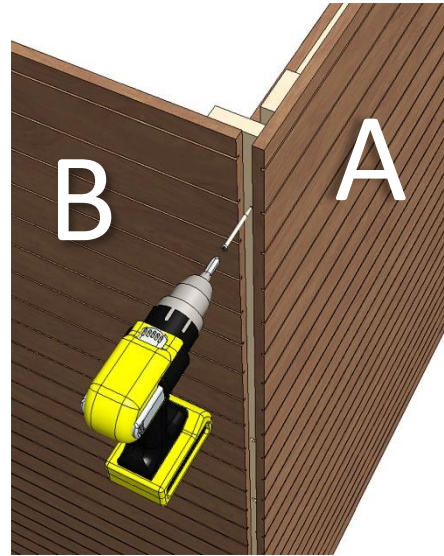
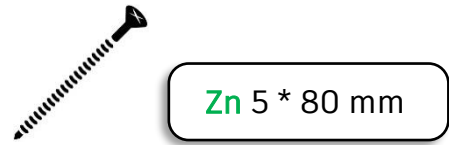
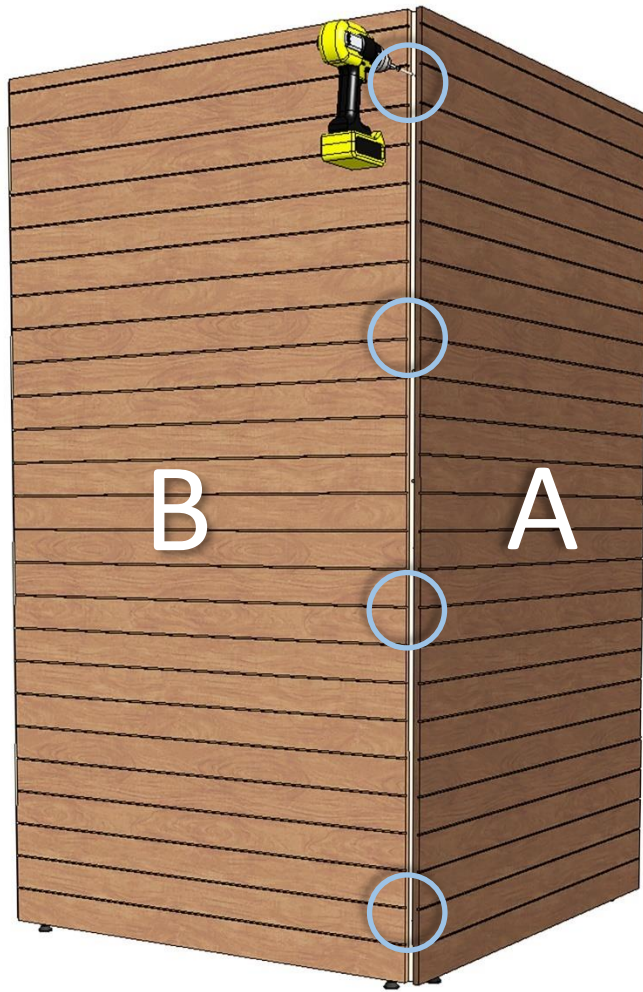

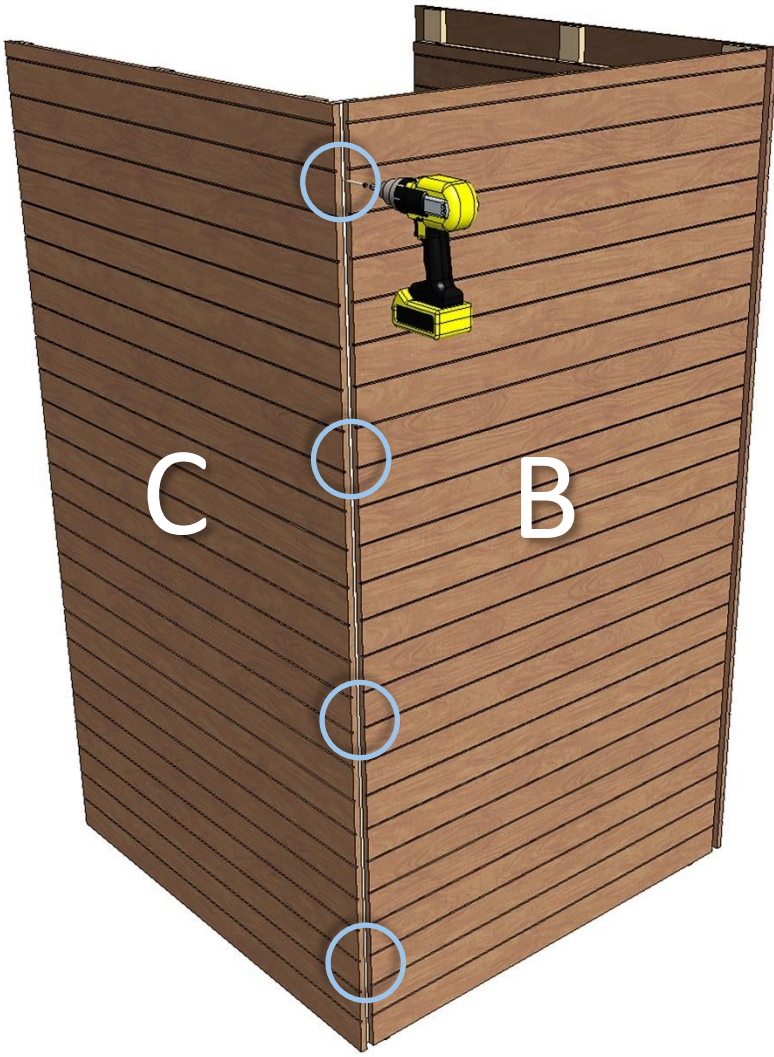

Zn 5 * 80 mm



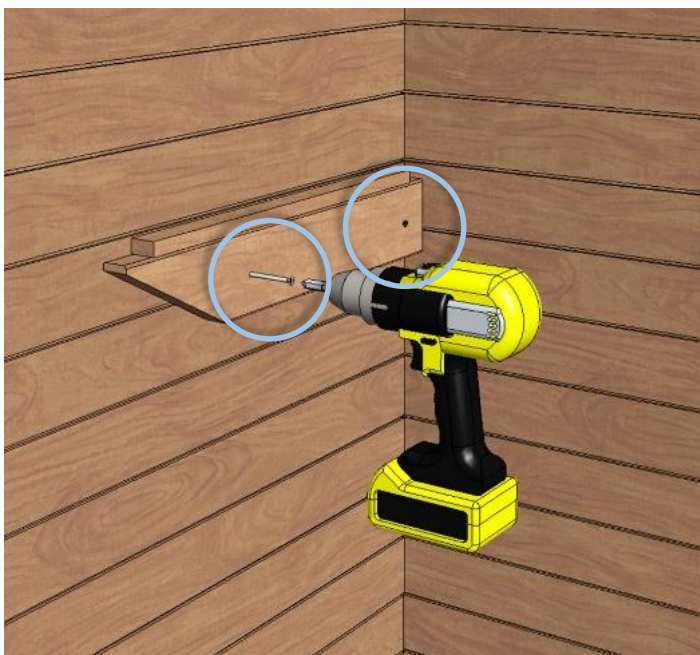
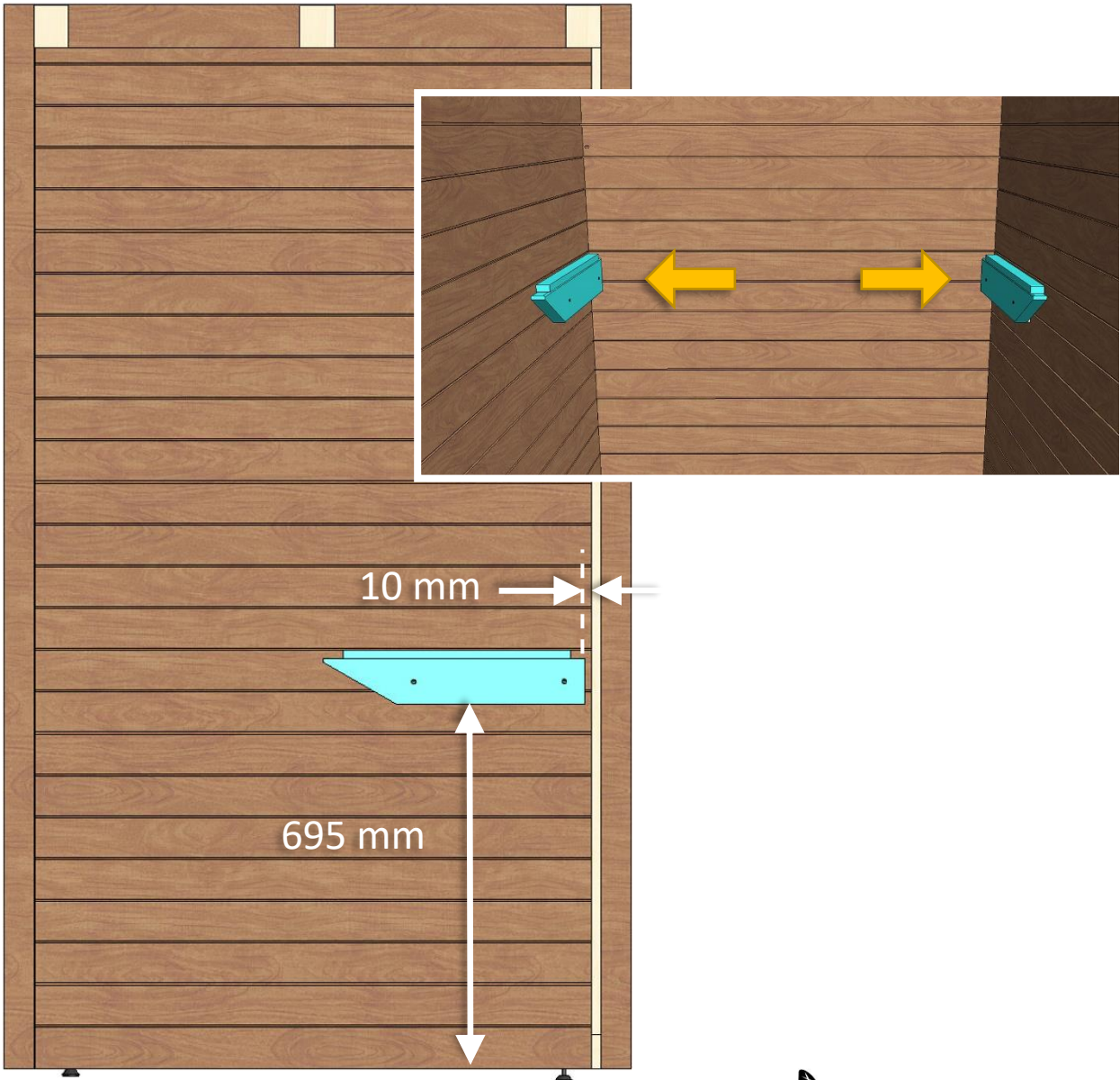

Ss 5 * 80 mm

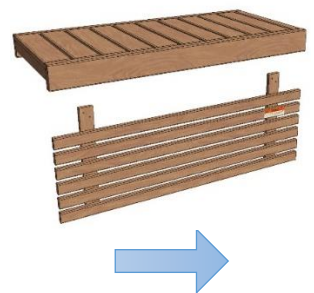

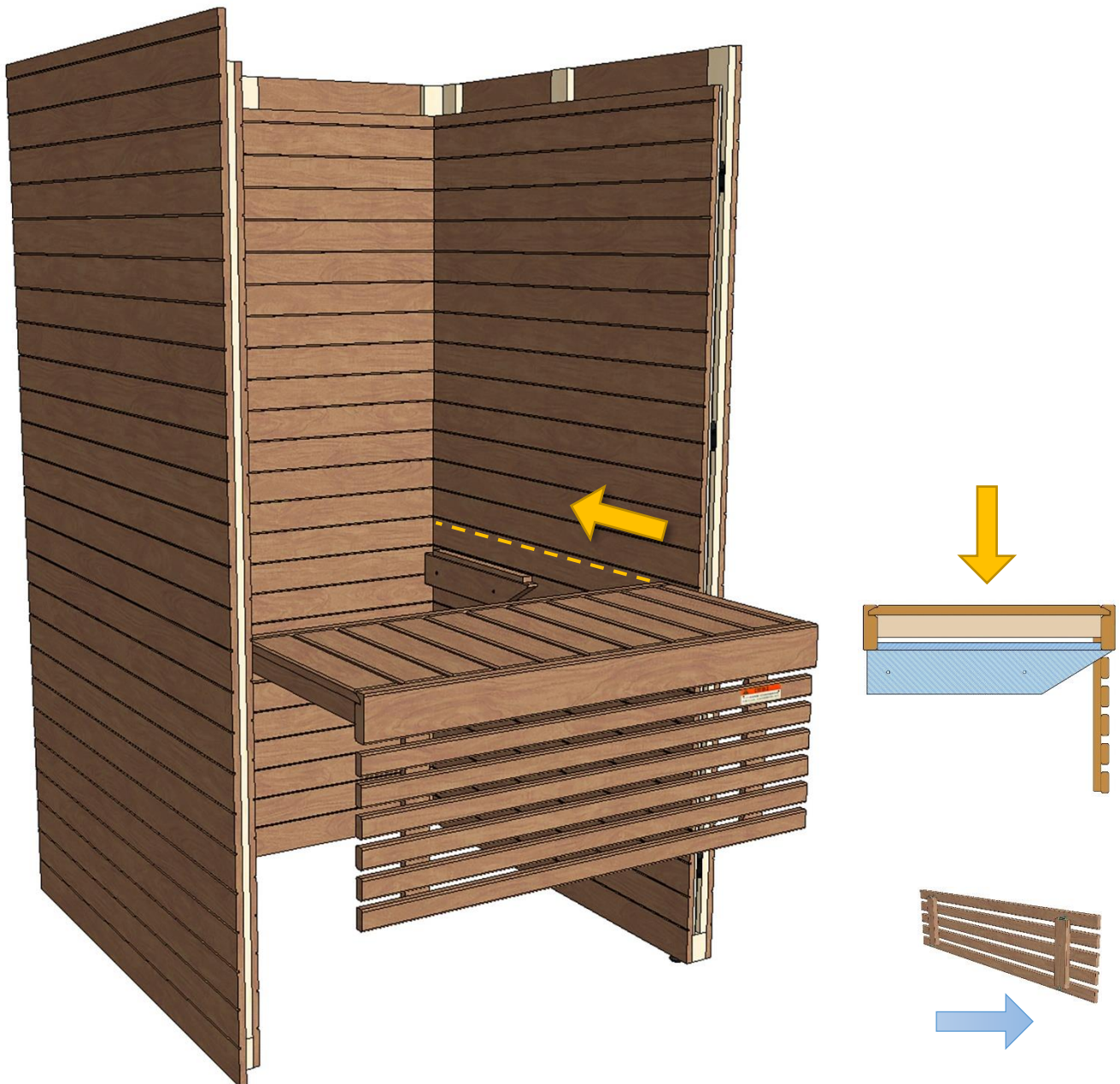
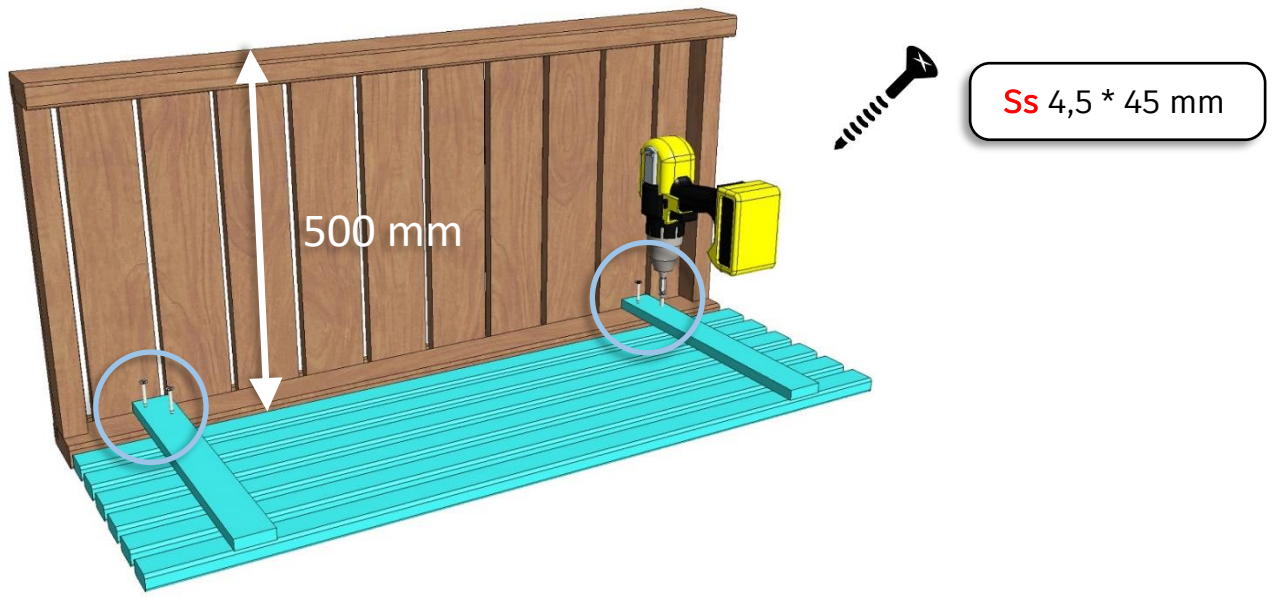

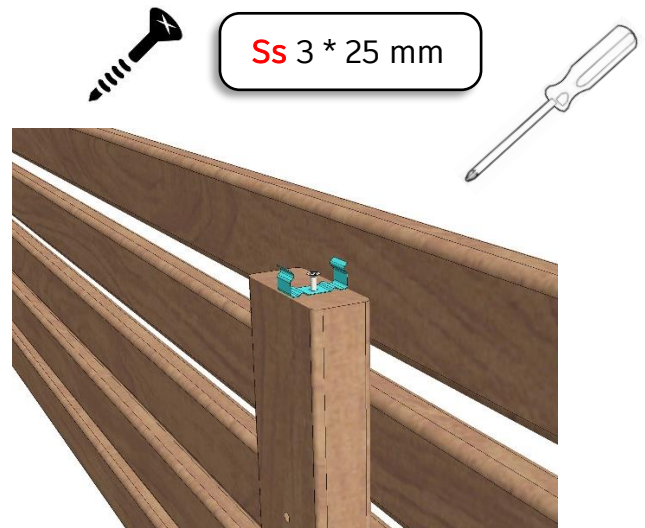
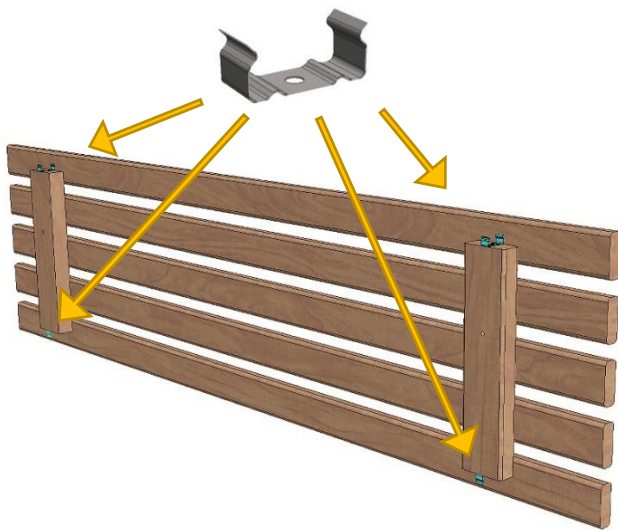

RGBW-LED 24V

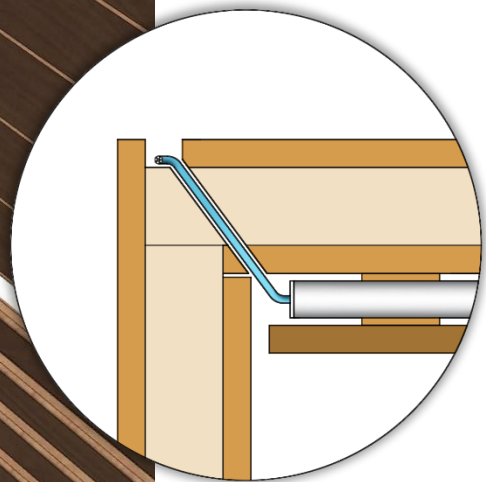
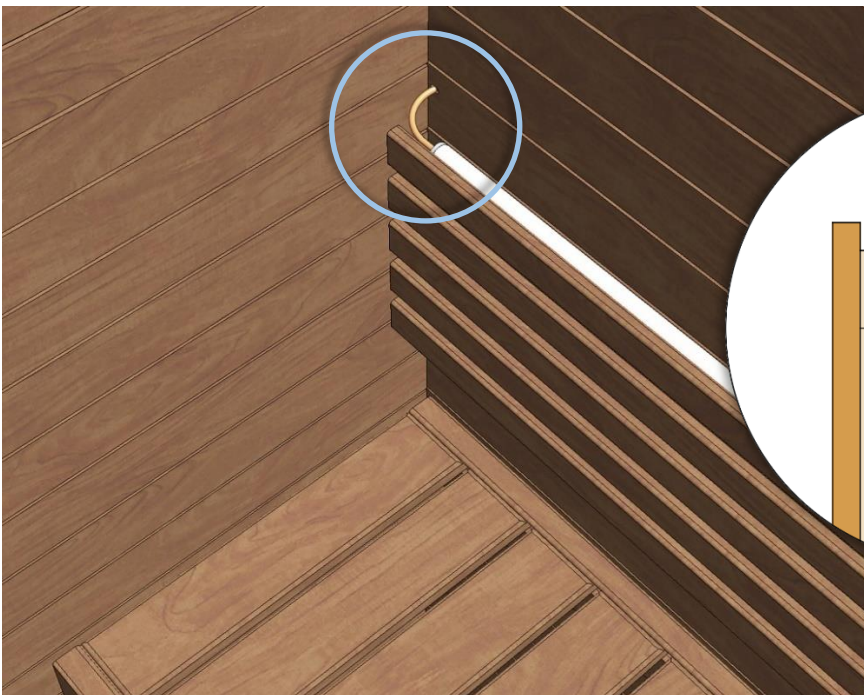
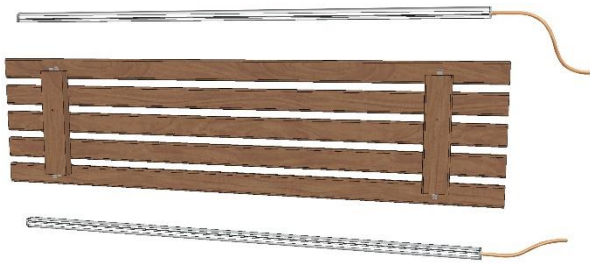

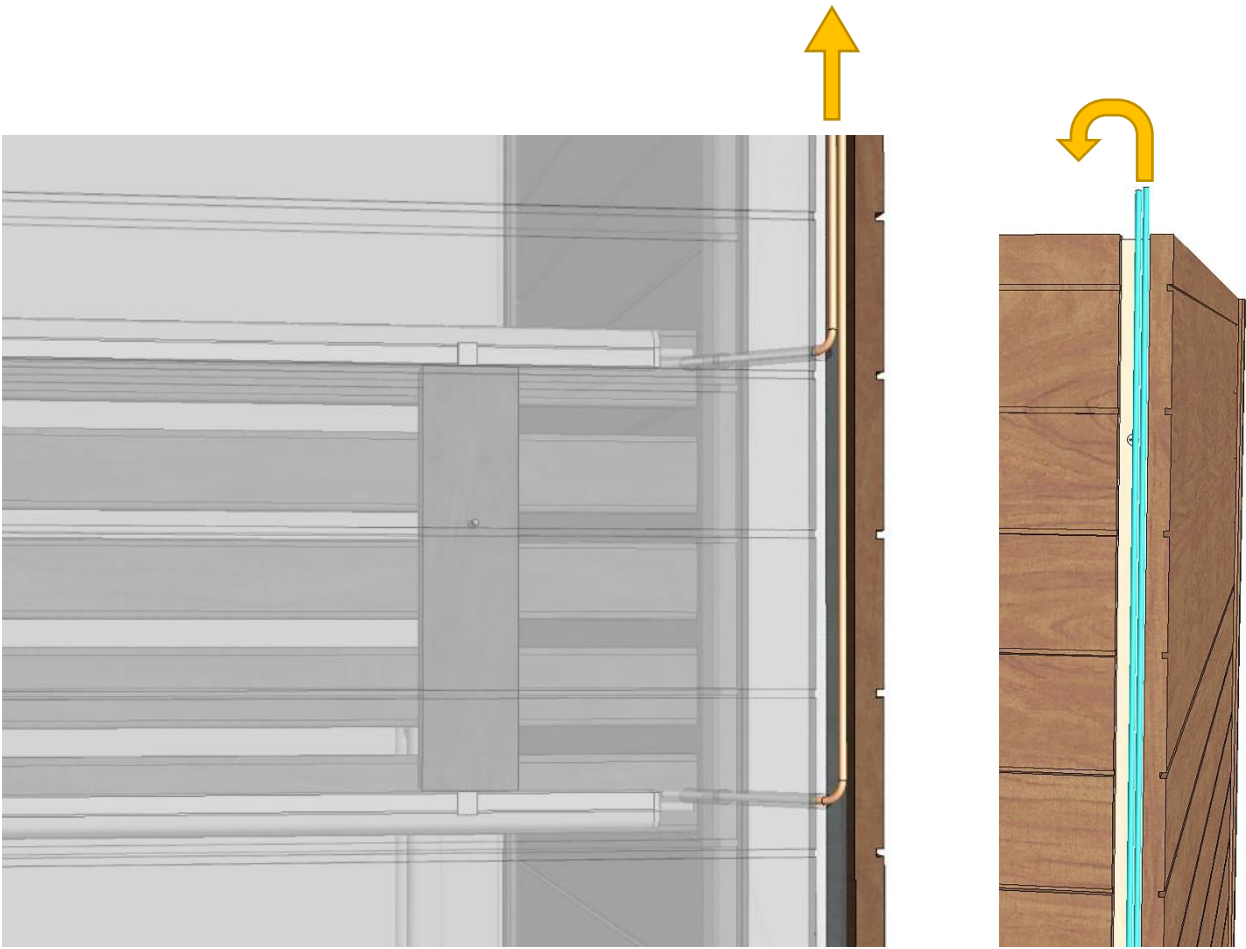

Ss 4,5 * 45 mm

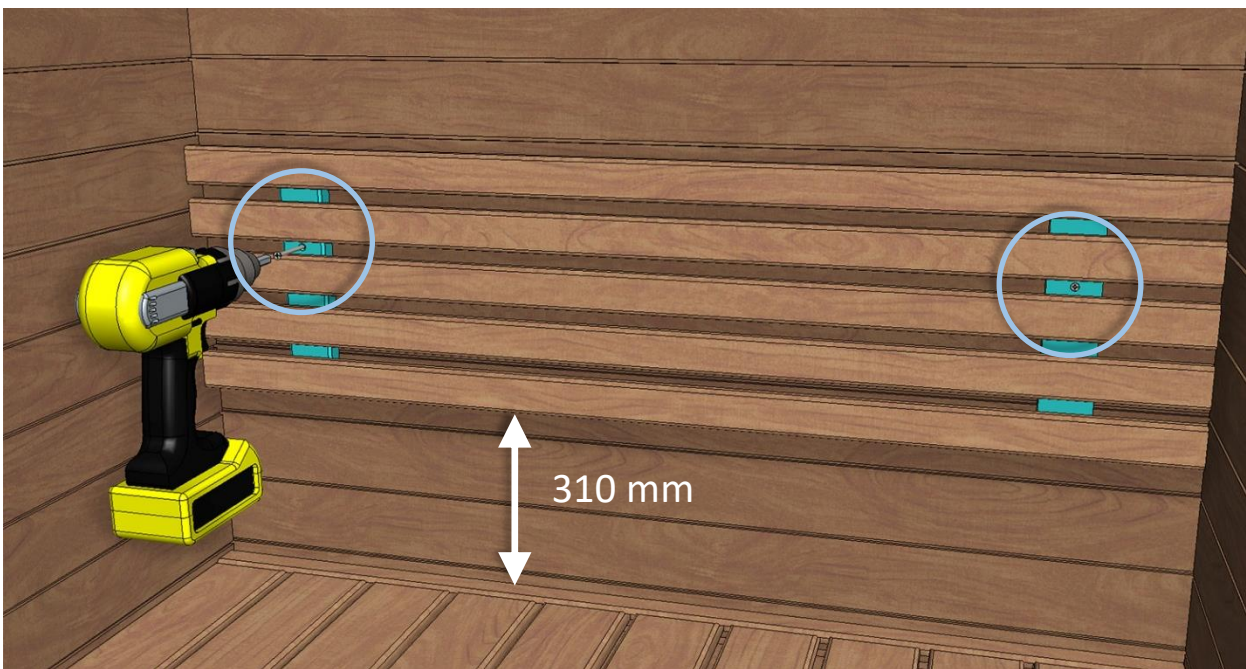

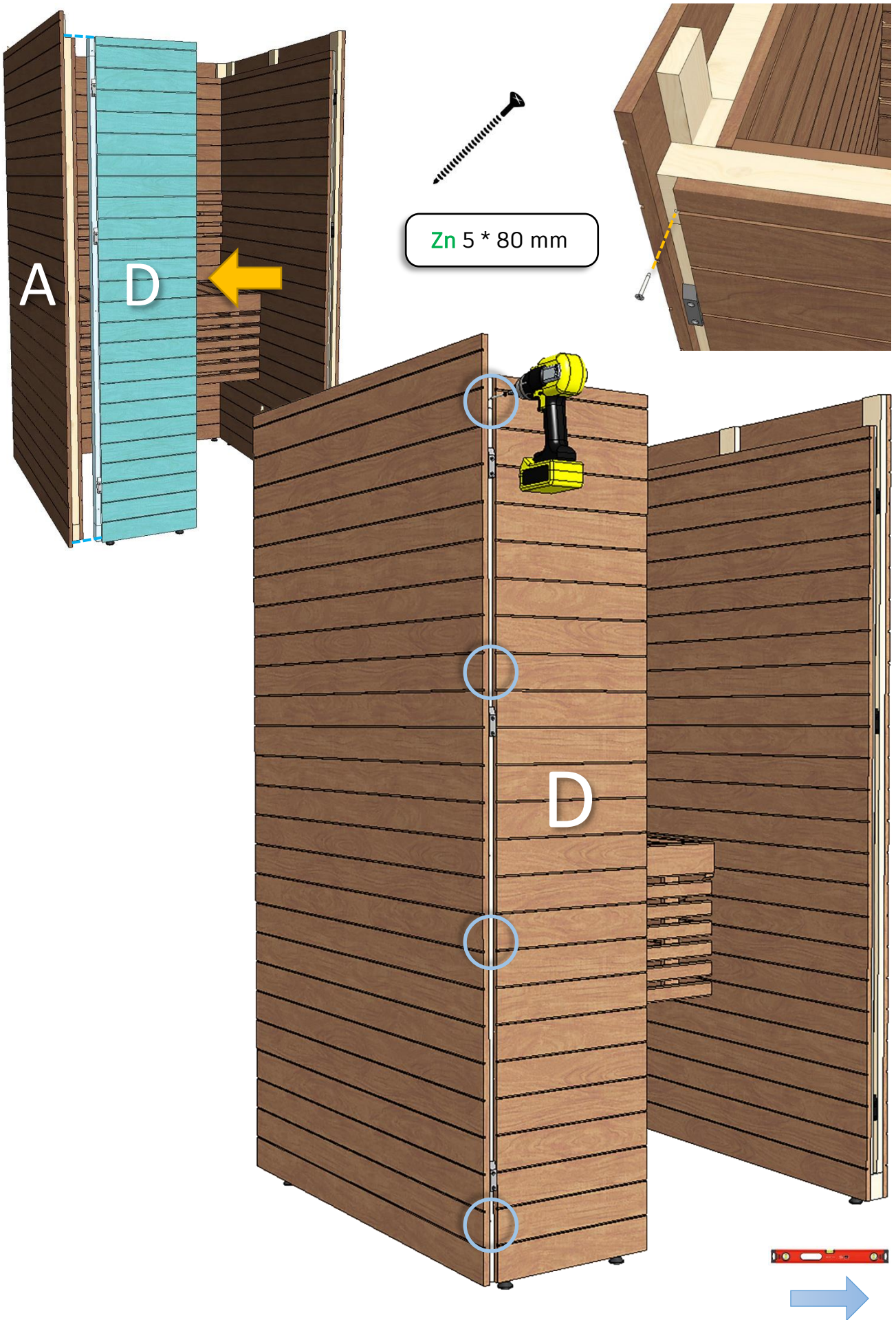

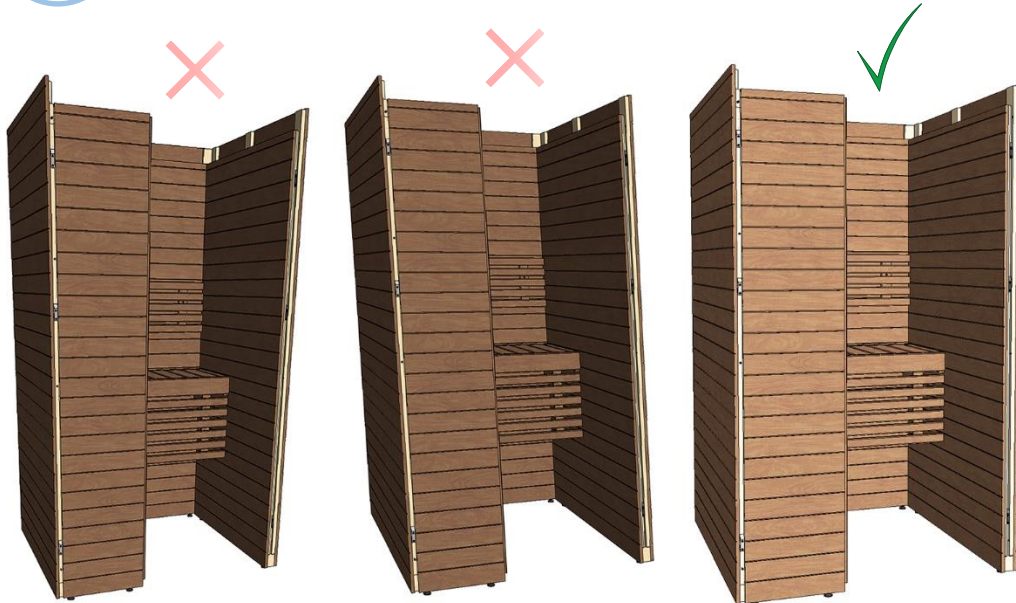
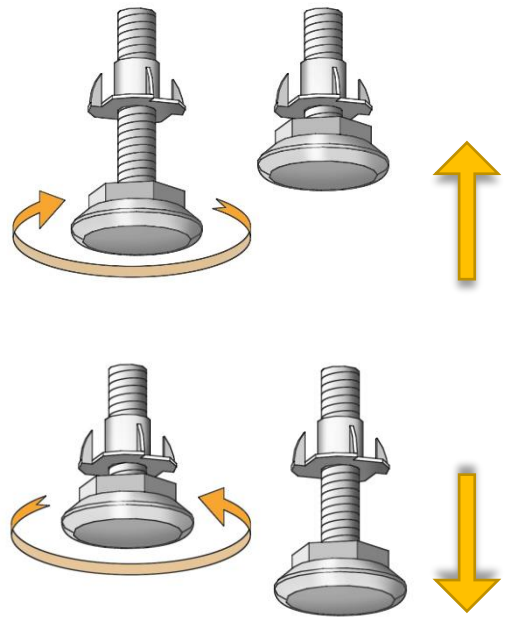

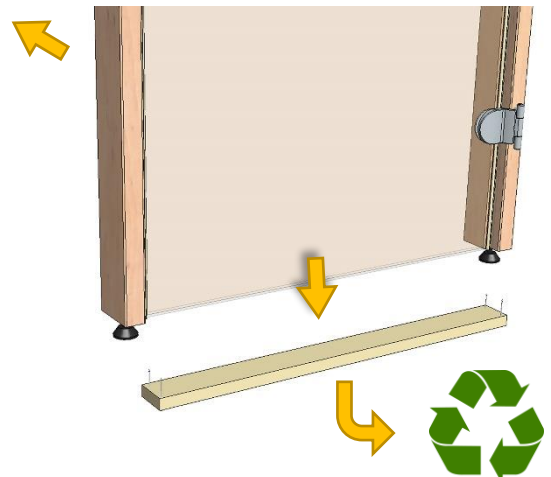
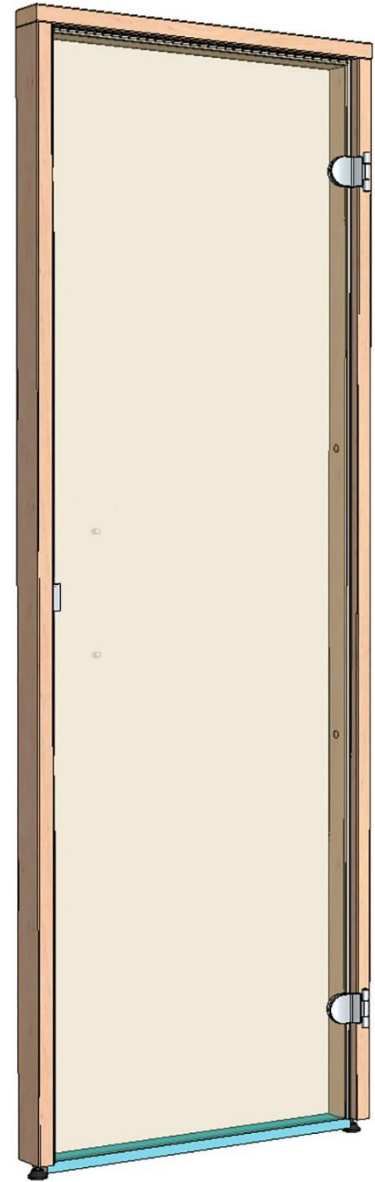
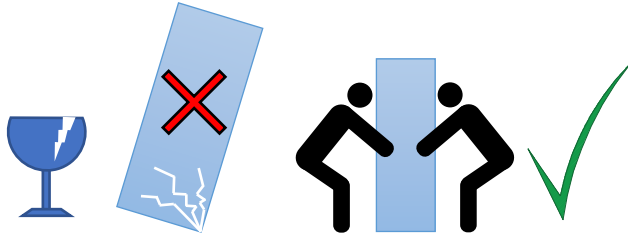

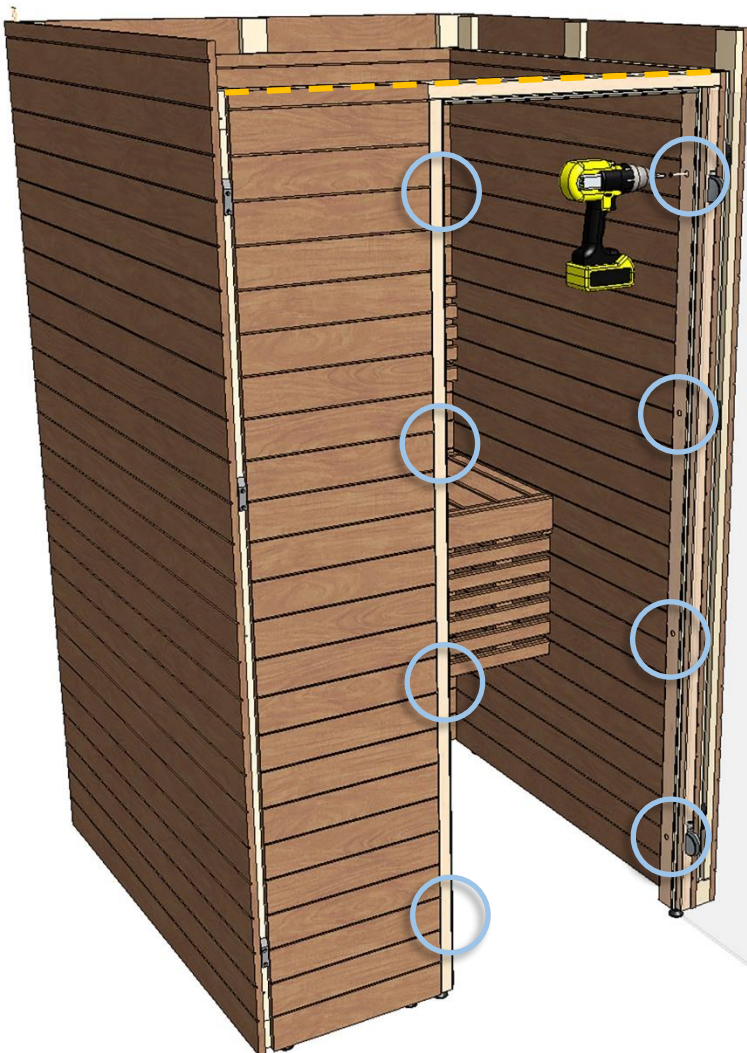
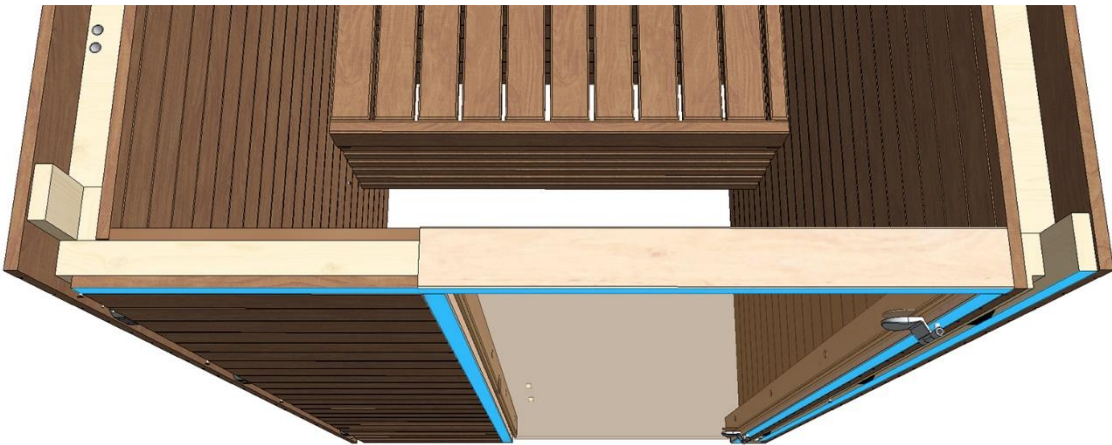
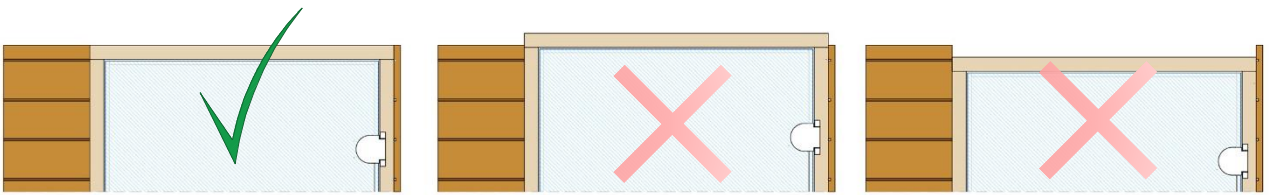

Zn 5 * 80 mm

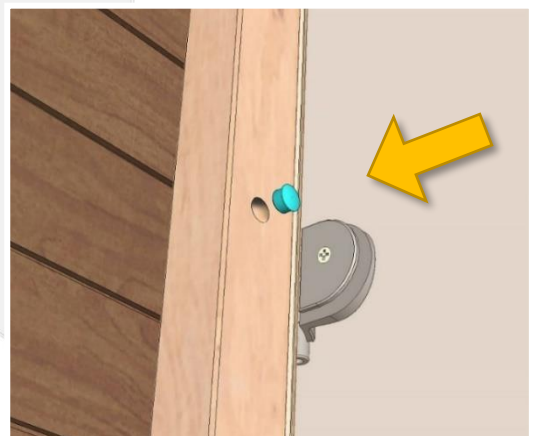

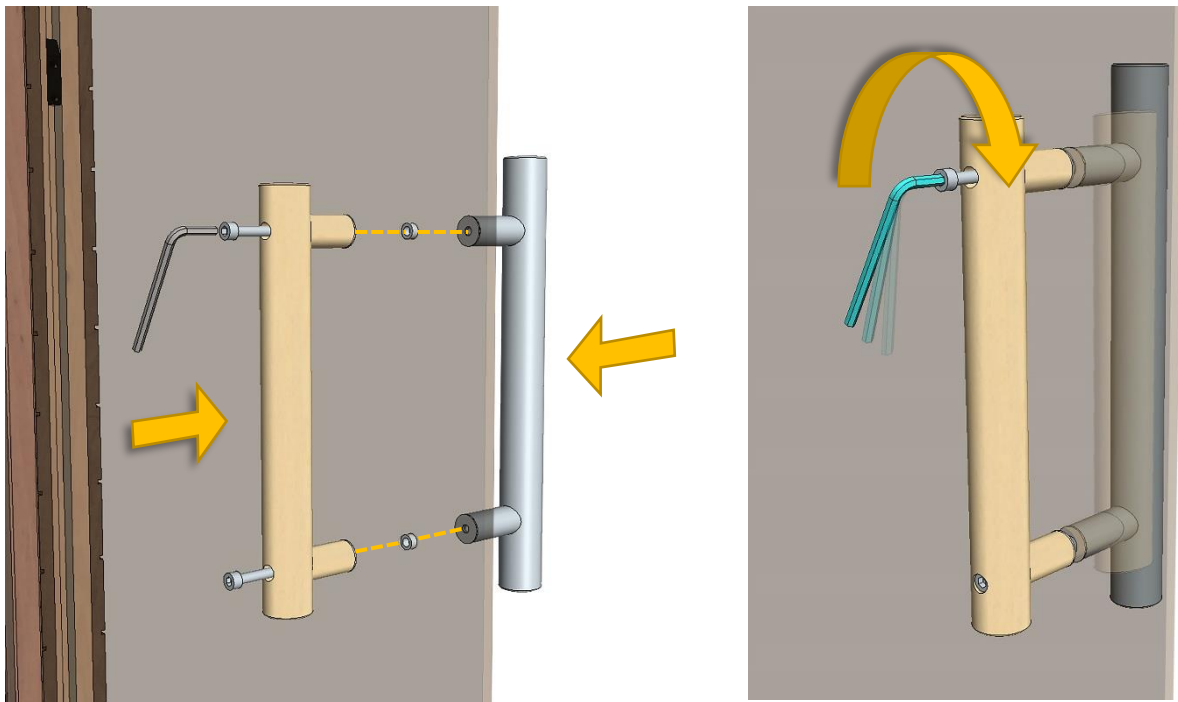
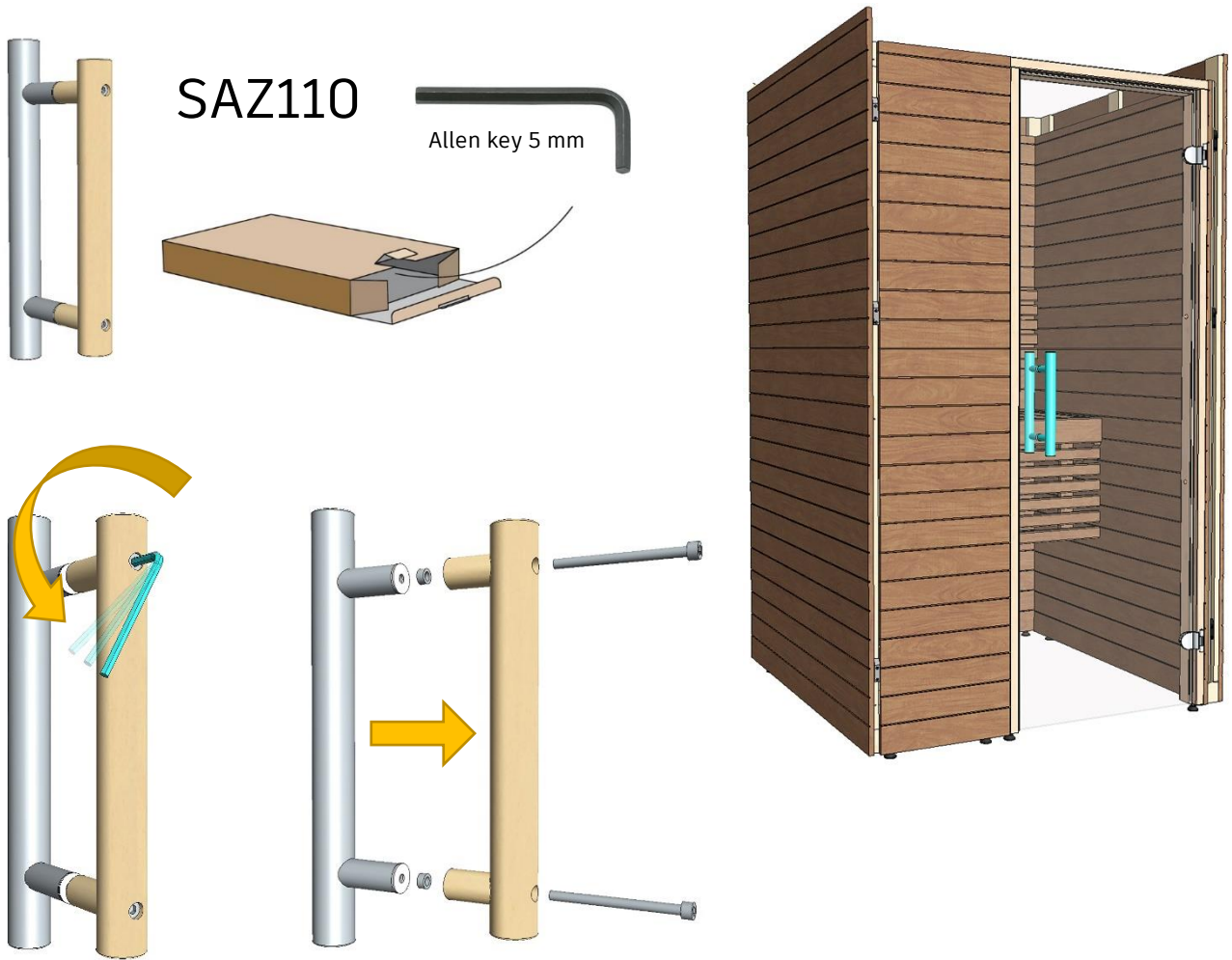

ZVEL-259C

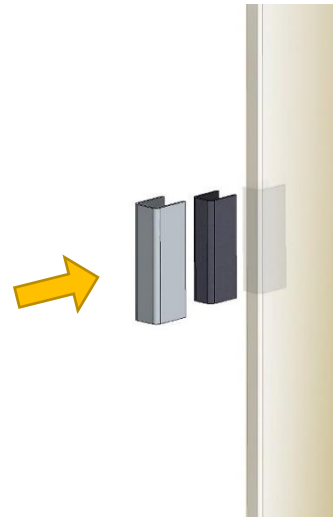
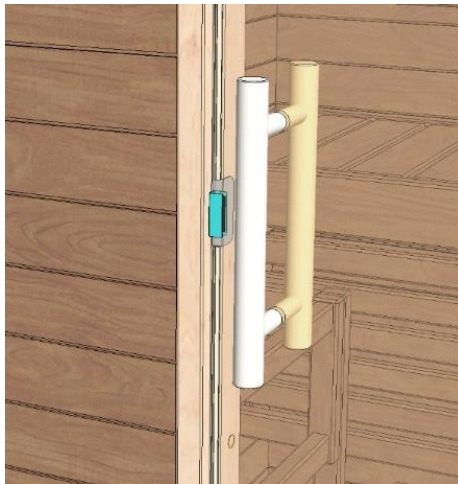

ZVEL-10

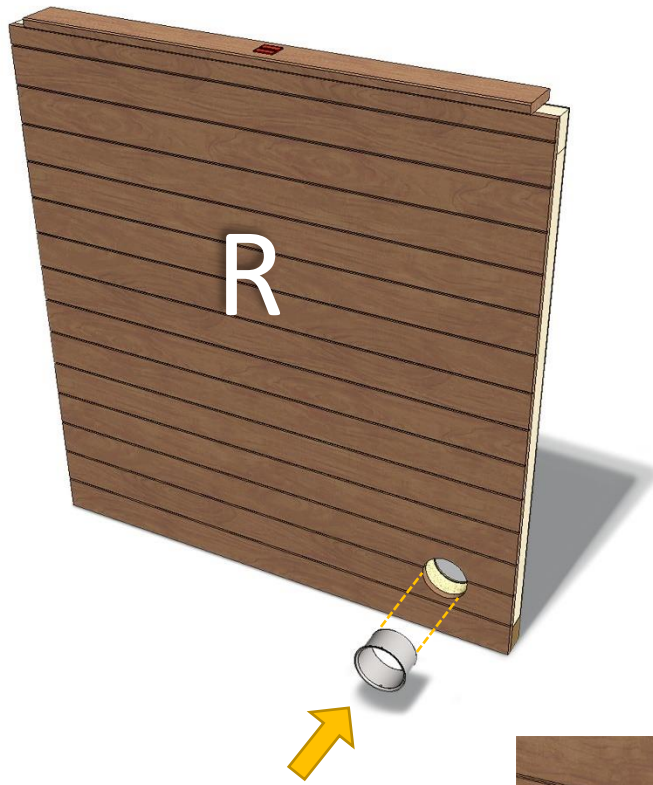
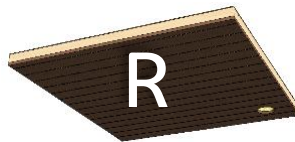

Ss 3 * 25 mm

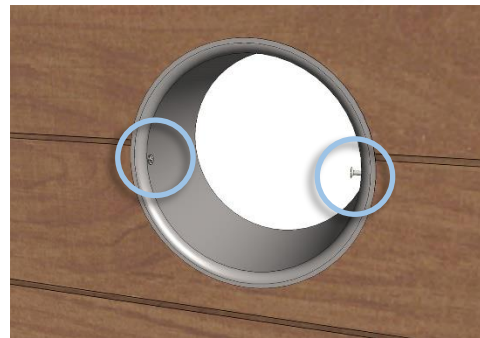

SZ093L

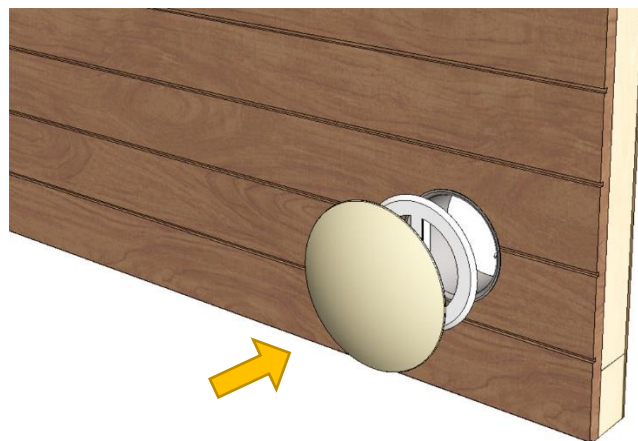



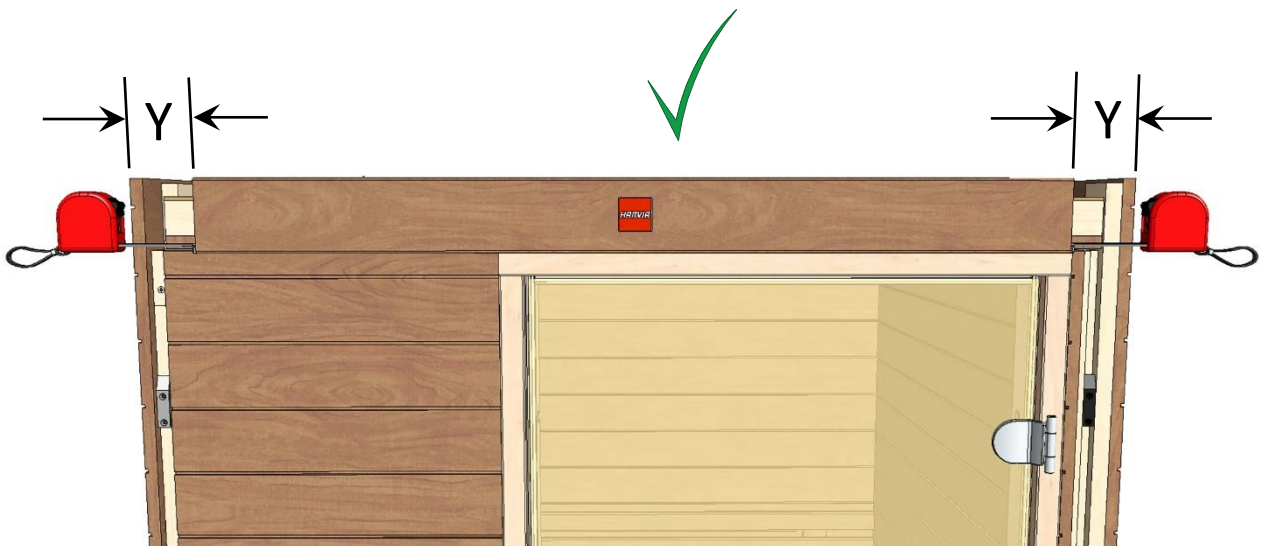
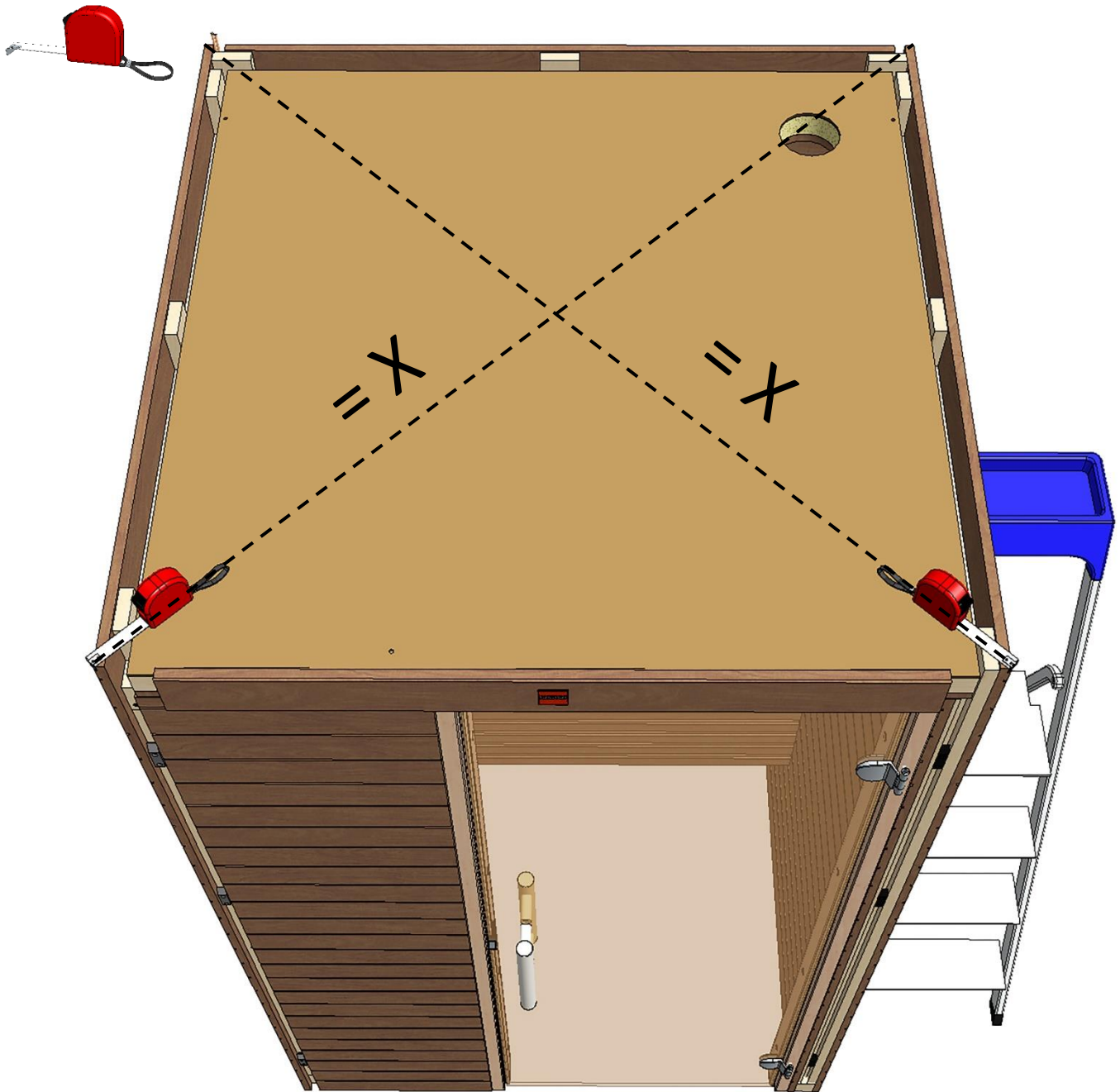

Zn 5 * 80 mm

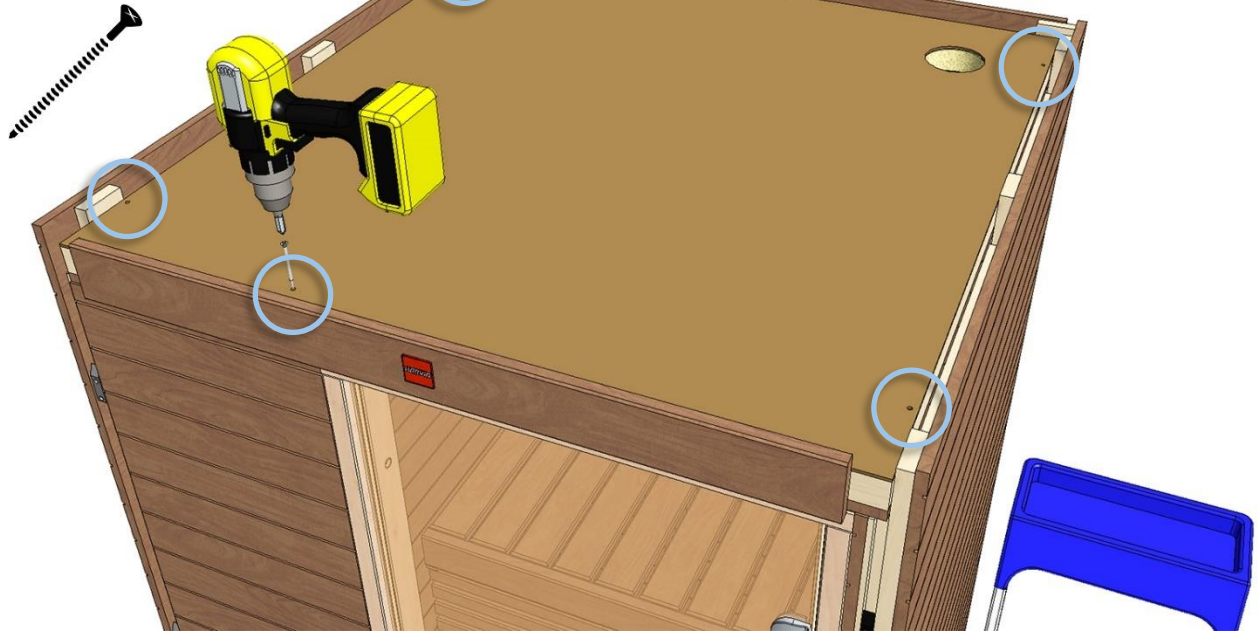

ZVEL-851

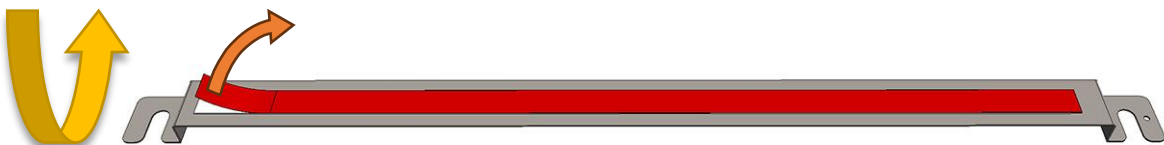
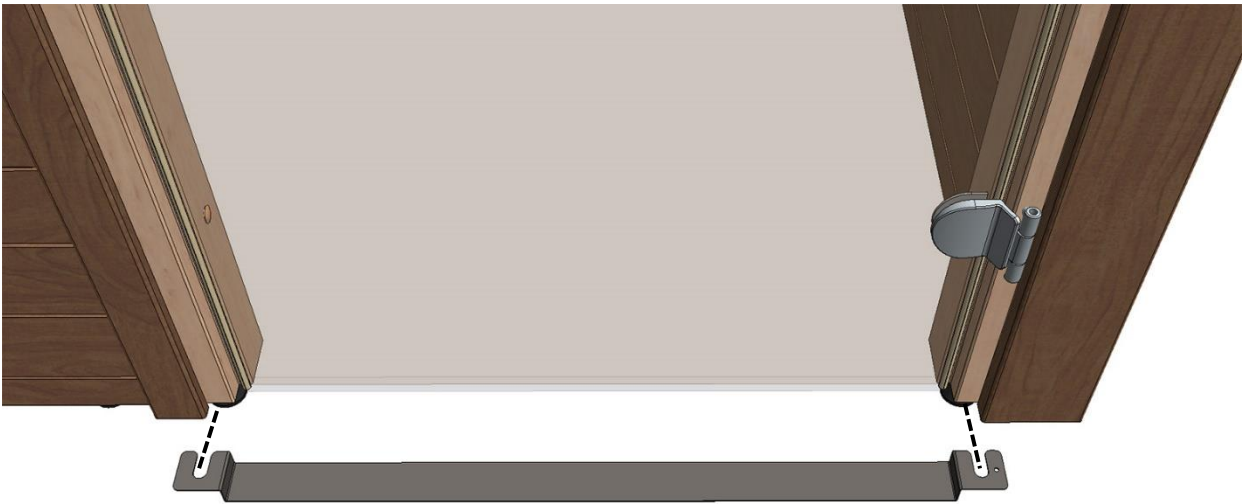

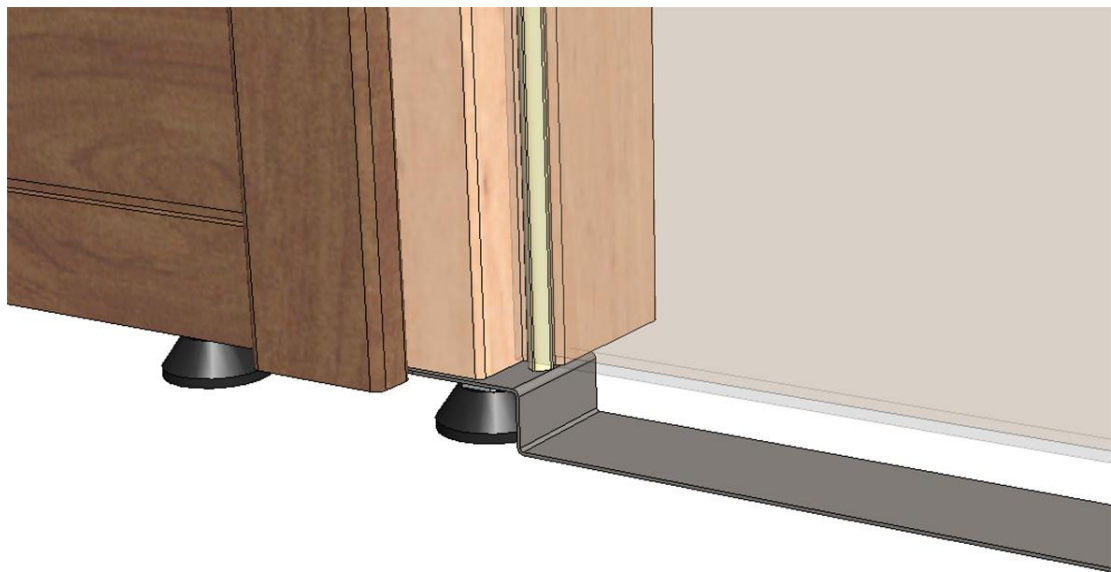
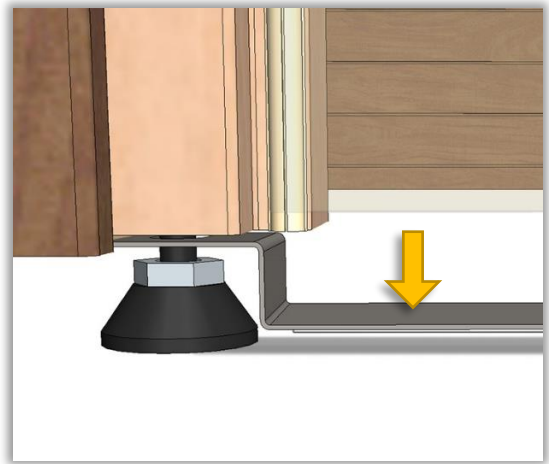
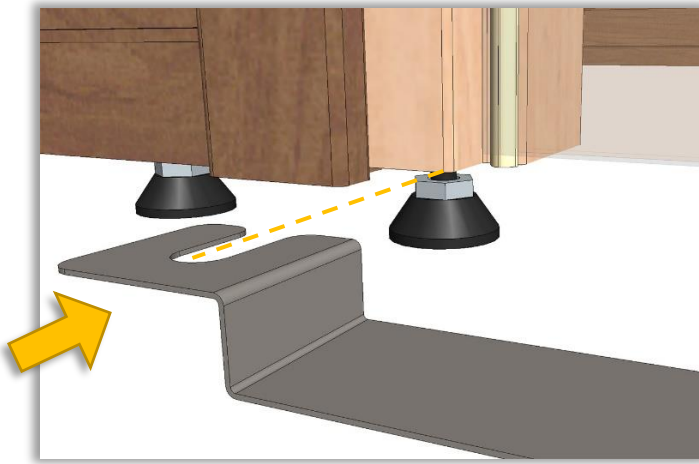



90 * 28 * 2034 mm



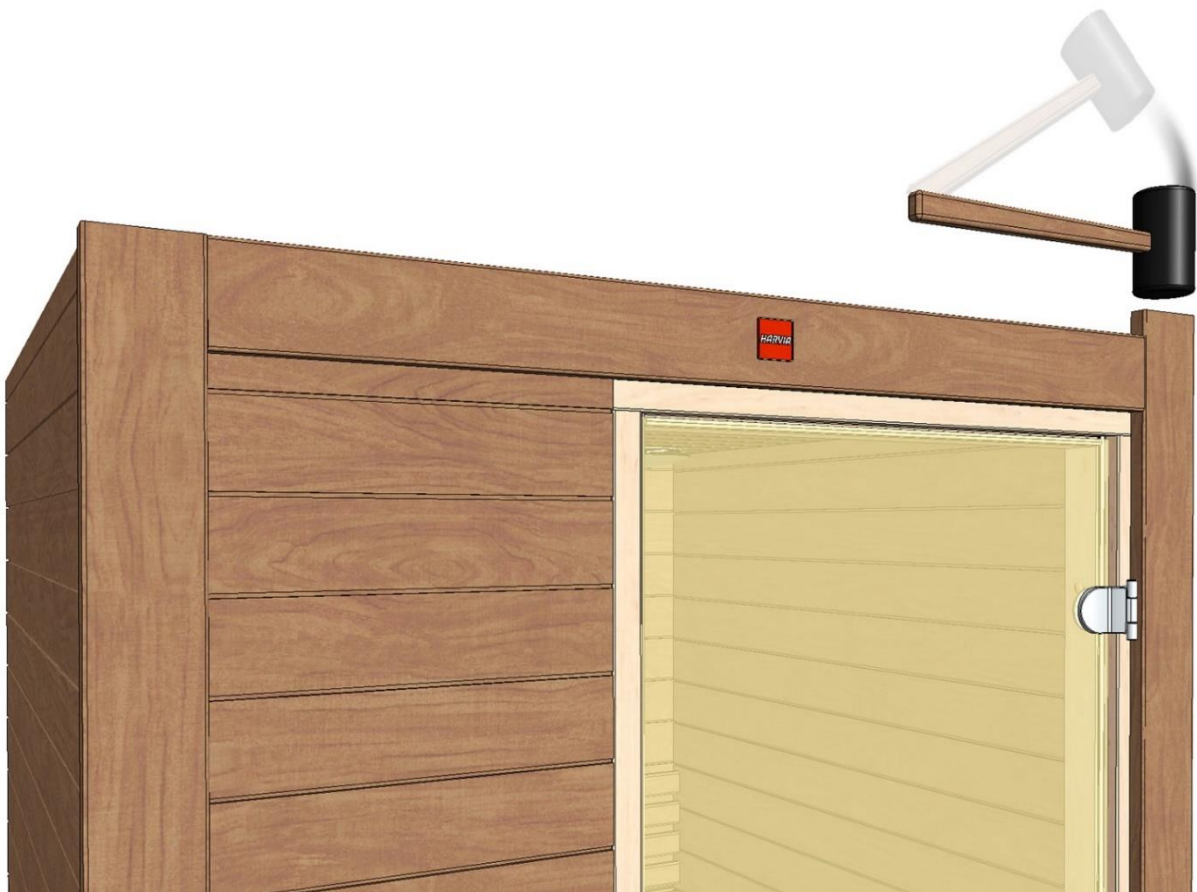

90 * 28 * 2034 mm



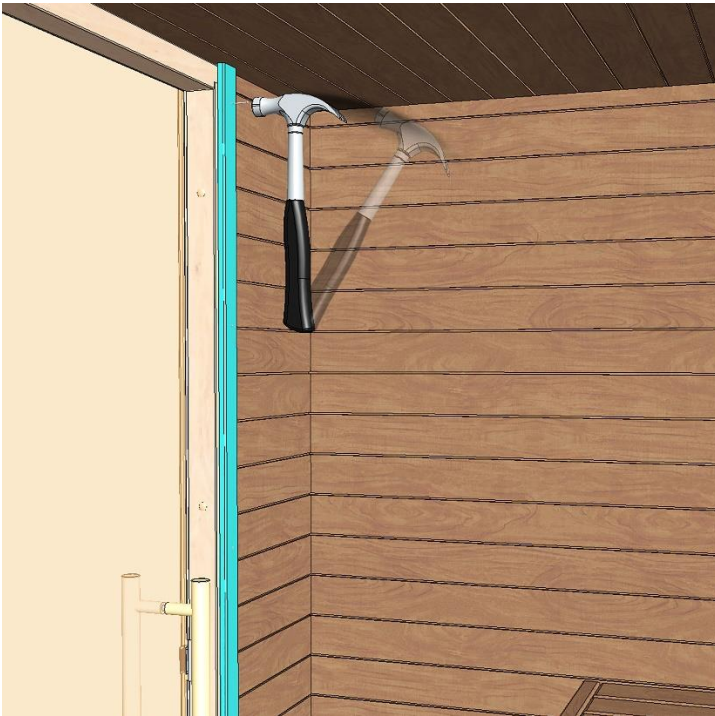

 45 * 15 * 1953



 21 * 42 * 2034 

 45 * 15 * 1953

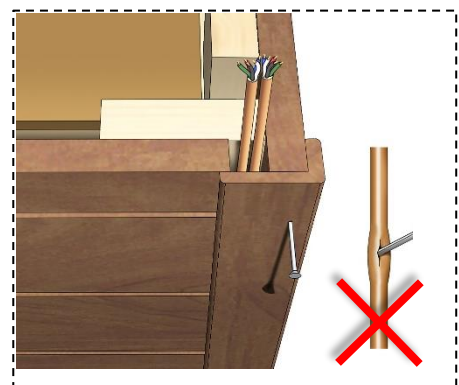
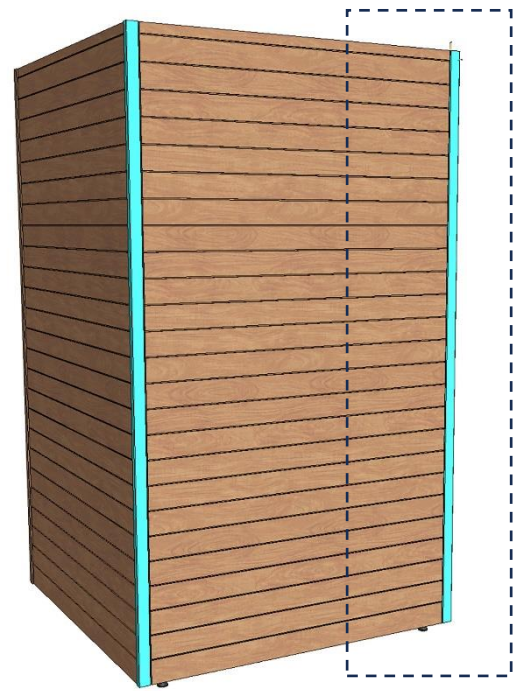
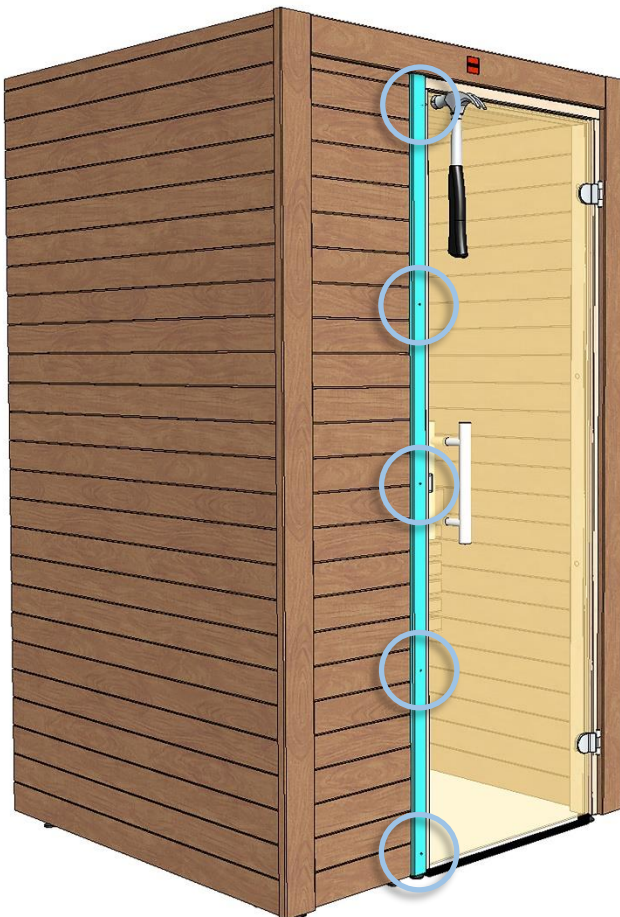

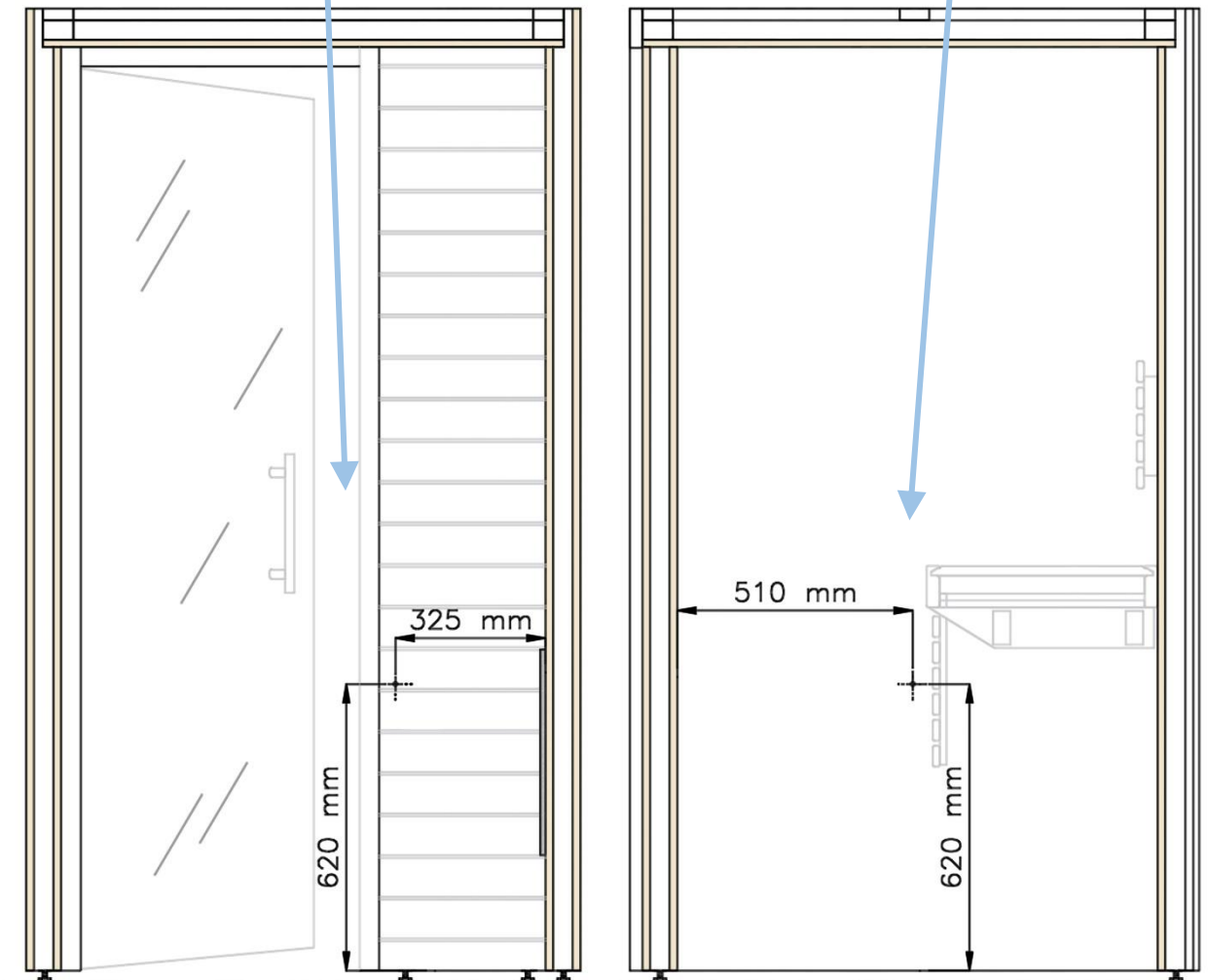
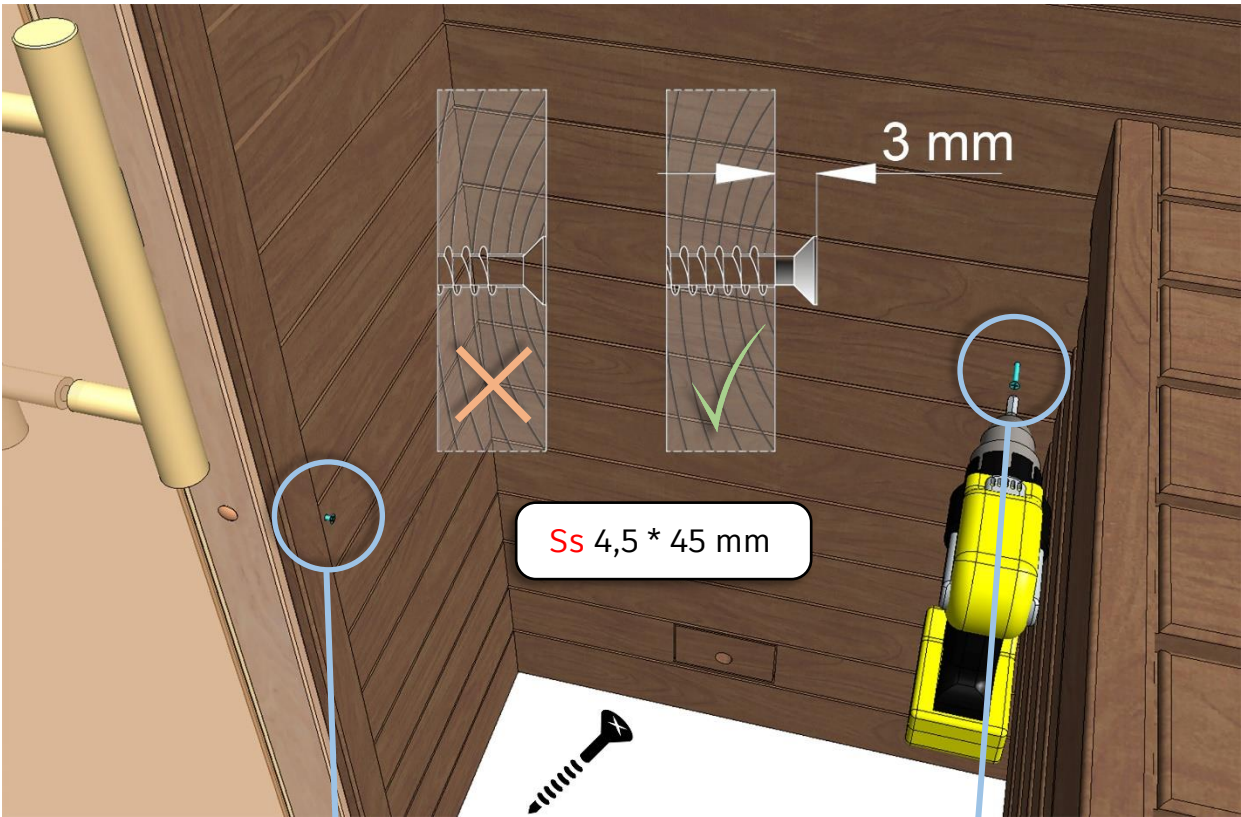

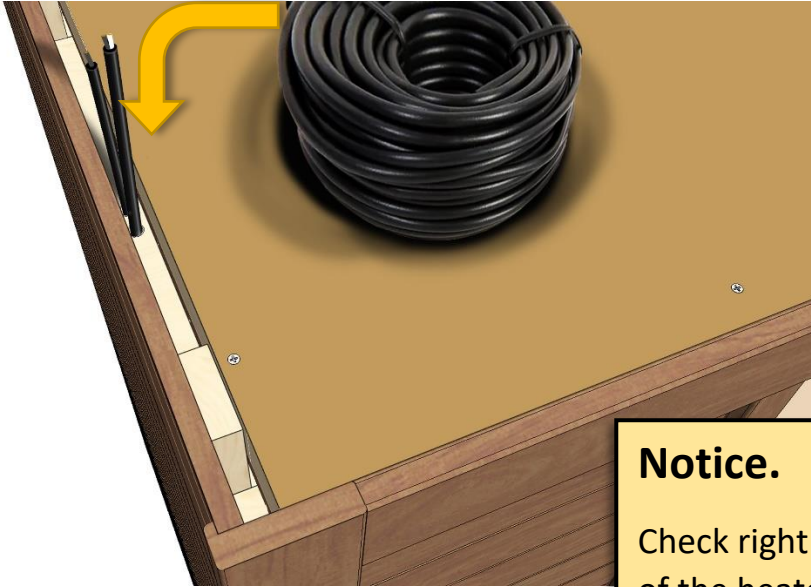

Notice.

Check right cables from the manual of the heater!

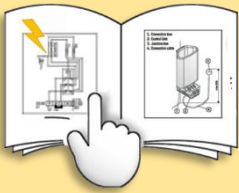
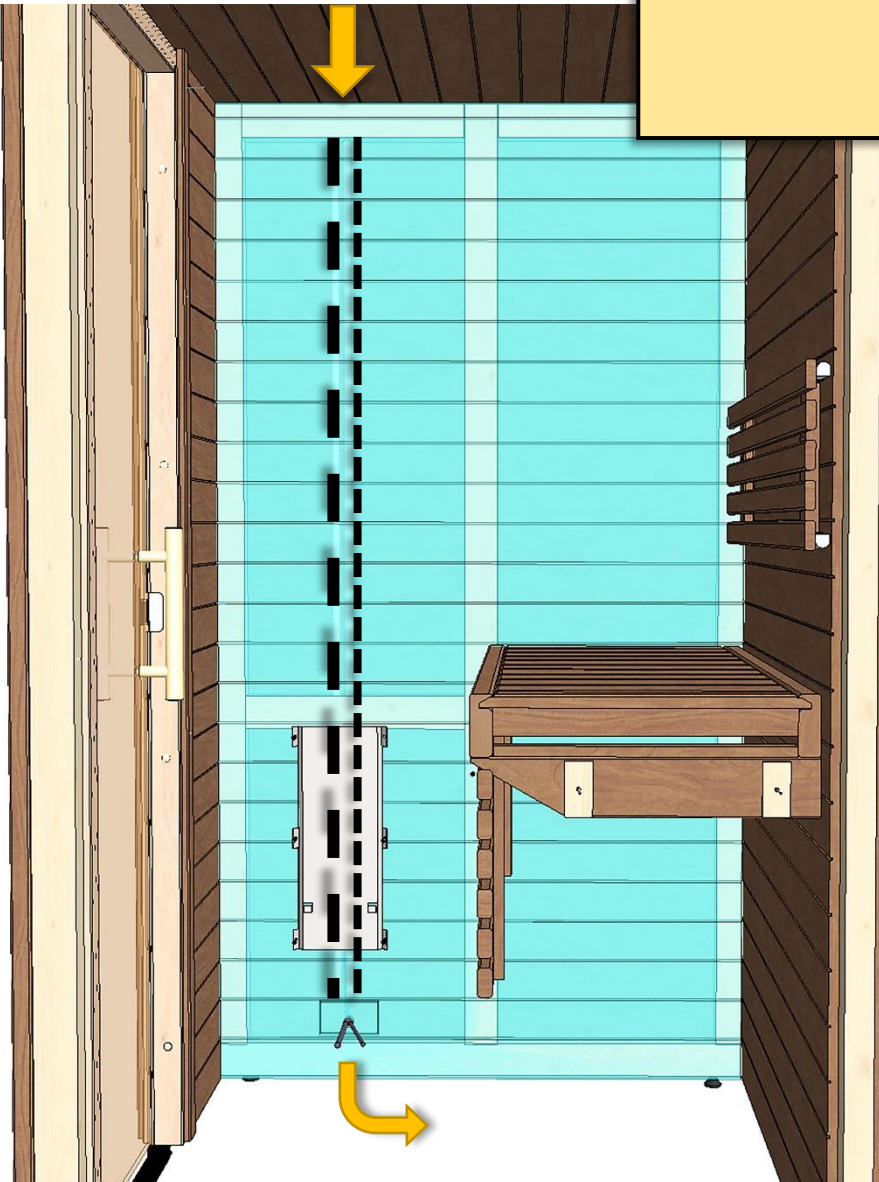
An icon of an open manual with a white hand pointing to a diagram on the left page. The diagram shows a heater unit with various components and a lightning bolt symbol, indicating electrical connections.

Notice!**Heater is not included.**

Recommended heater for this sauna is Delta D36 (3,6 kW).

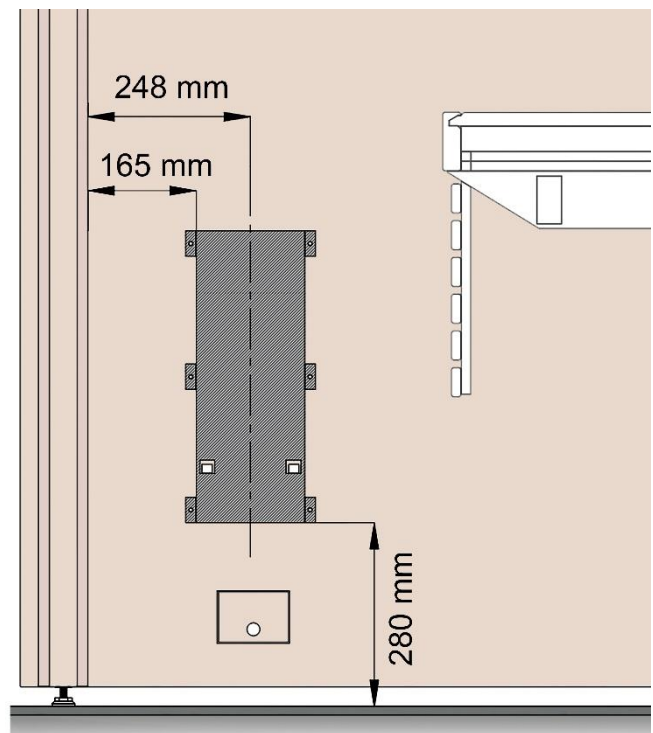
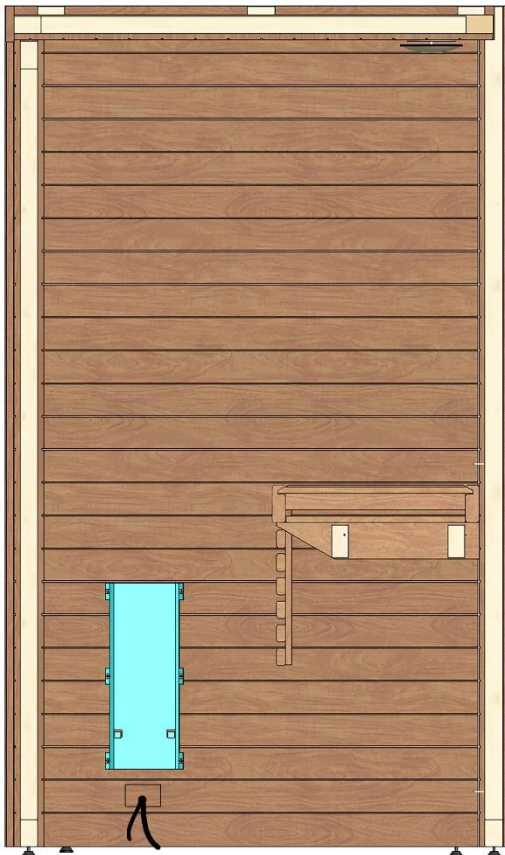
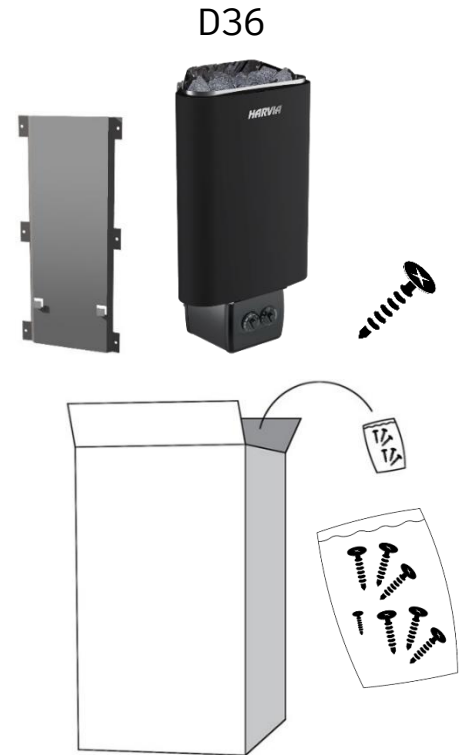

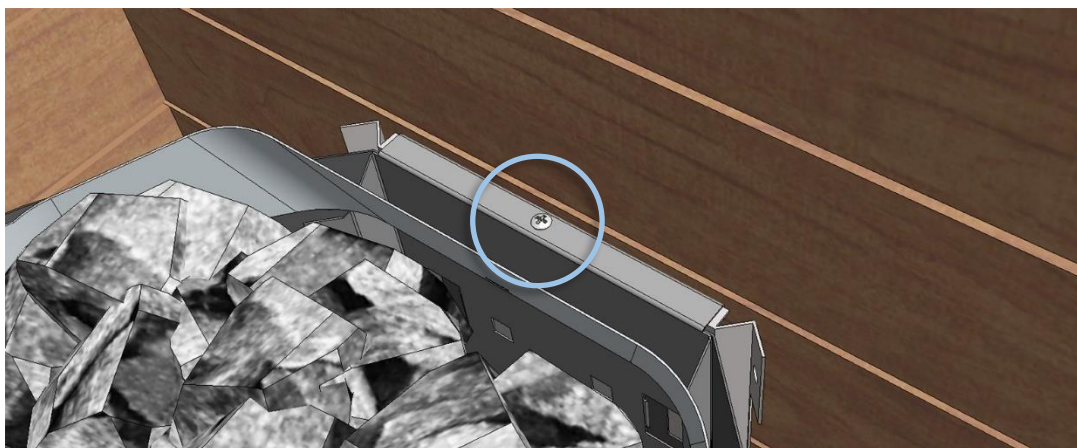
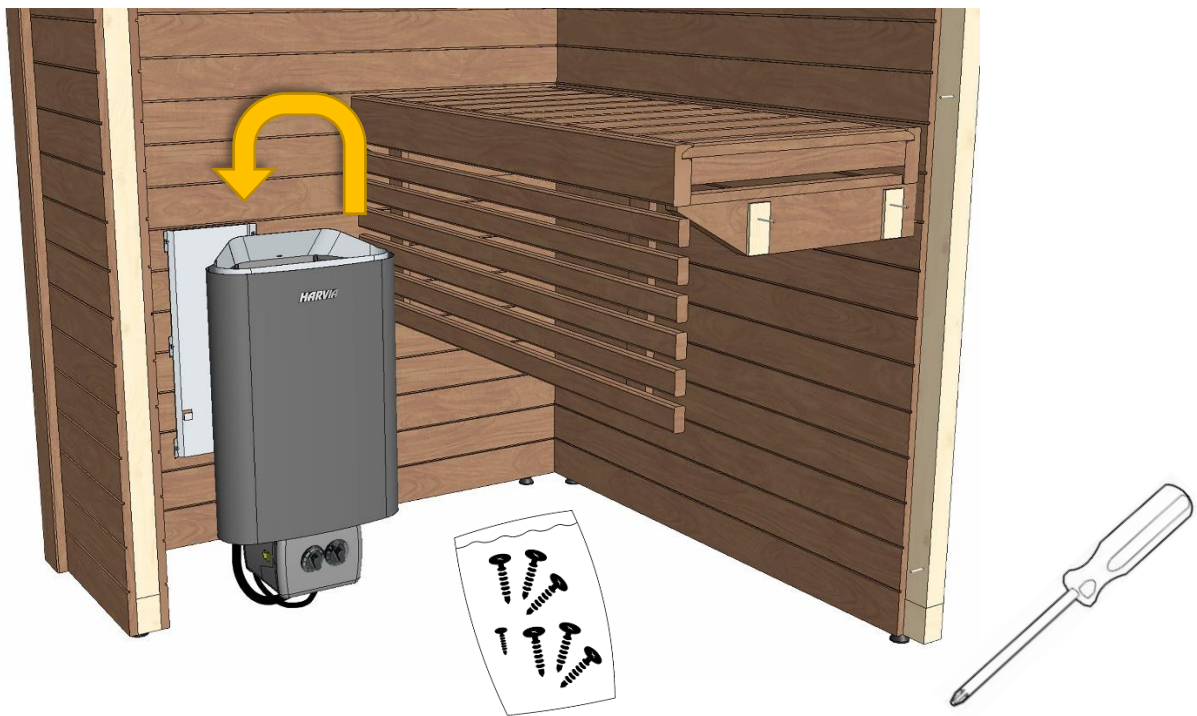
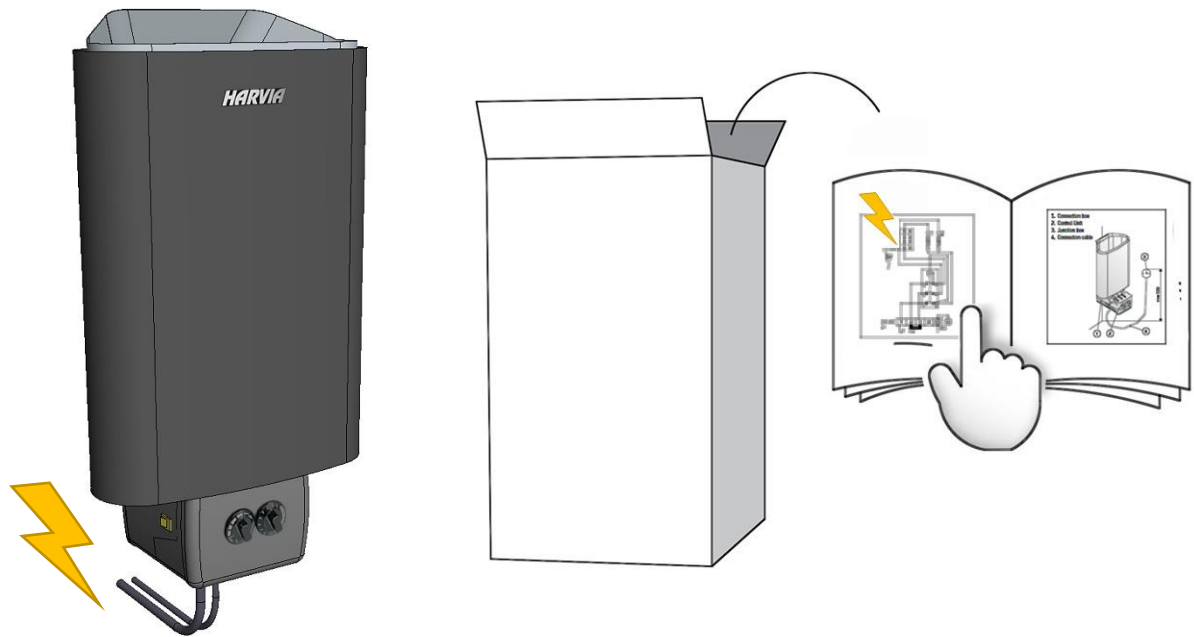

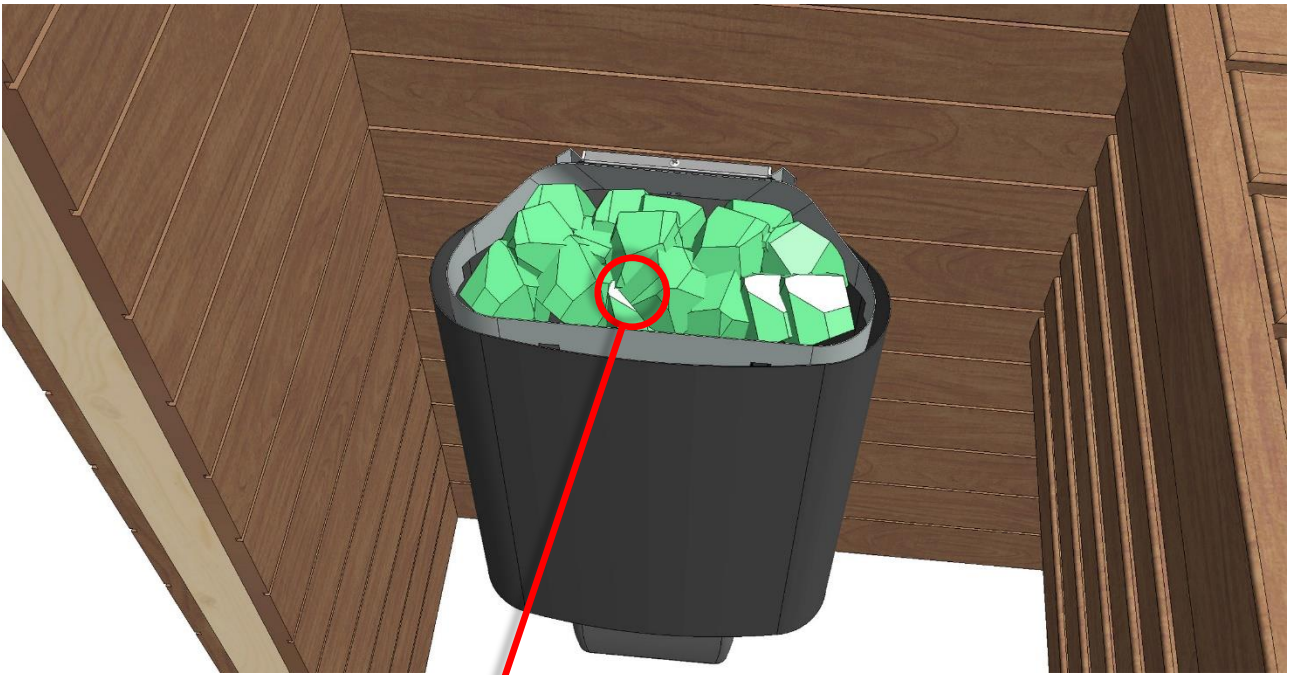

AC3000

